



CreatBot 3D Printer

User manual

English V7.4

CONTENTS

Notice	3	Mouse Operation	23
Machine Diagram		Model Rotate/Scale	24
Front	4	Right Click on Model	25
Printer Head	5	Toolpath Structure	25
Hardware Installation		Model Mirror	26
Unpacking	6	View Mode	26
Printer Operation		Basic Setting	27
Leveling Platform	7	Advanced Setting	28
Paving Crepe Paper	7	Expert Setting	29
Load Filament	8	Skirt/Brim/Raft	30
Unload Filament	9	Plugins	30
Main menu	10	Start/End Gcode	31
Detail page	12	Dual Head Printing	31
Printing page	13	Add Multi Type Printer.....	32
Axis operation	14	Using skills	
Filament menu	15	Change Fuse	33
SD Card/U-disk	16	Installation section	34
Setting menu	17	Software	35
Info. menu	19	Adjust Z Limit	35
Software Operation		Frequently Asked Questions	
CreatWare Setup	20	Hardware Troubleshoot	36
Quick Print UI	21	Printing Troubleshoot	37
Print Your First Model	21	Specifications	
Full Setting UI	22	Specifications	40

Icon conventions



Tip icon to remind users to have a good method or technique.



Note icon, to remind the user must be given adequate attention.



Prohibition icons, prevents users from unauthorized operation.

Notice

Read First

Thank you for choosing CreatBot 3D printer!

This manual contains important information about the installation, use, maintenance and common problems of CreatBot 3D printer. Please read this manual carefully before using 3D printer. All losses caused by the breach of the notes and the operation process of the operation process will be borne by the user. Please use the filament provide by CreatBot, or high quality filament by third manufacturers. Due to the use of third party inferior material caused by the failure of the printer, the loss will be borne by the user.

Software running environment, 2G or above processors, at least 1G memory, compatible with Windows, MAC, or Linux, please use memory as much as possible.

I wish you have fun with CreatBot 3d printer!

Danger Warning



The nozzle's temperature will reach 300 degrees, don't touch.



The platform's temperature will reach 120 degrees, don't touch.



Please make sure that the printer connected to the ground.



Do not attempt to open the case, be careful of electric shock.

Working Environment



The 3D printer can work in the indoor environment of 5 °C to 30 °C.



Long-term not use of the printer, be sure to dust, moisture.



Long-term not use of the filament, please be sealed to prevent deterioration.

Machine Diagram

Front

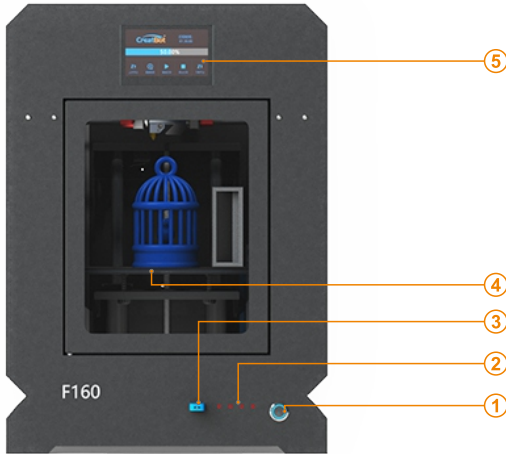

- 1. Power switch
- 2. Indicator light
- 3. U disk
- 4. Build platform
- 5. Touch Scanner

Indicator light

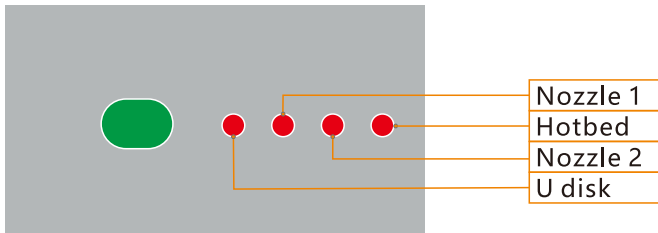

Machine Diagram

Printer Head

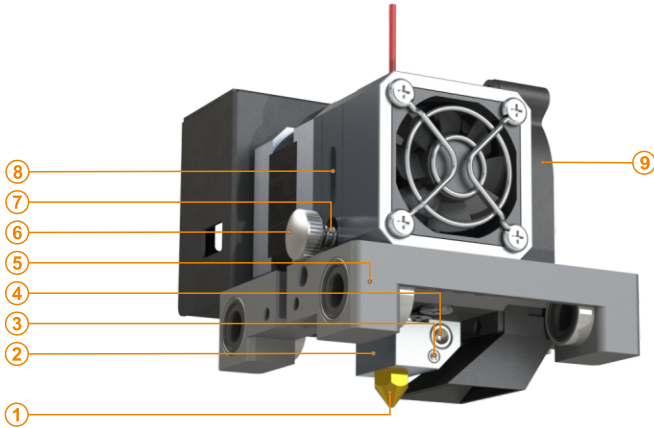

- 1.Nozzle
- 2.Heating block
- 3.Thermostat tube
- 4.Heating tube

- 5.Extruder block
- 6.Pressure nut
- 7.Pressure spring
- 8.Pressure arm
- 9.Cooling fan

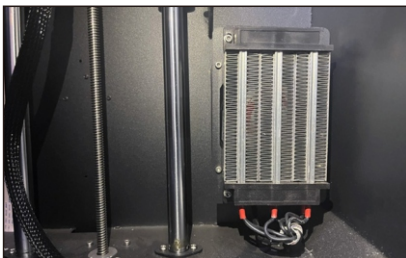

Hot air chamber can provide constant room temperature so that model won' t deform when printing.



Brass heating blocks are more resistant to high temperatures with special heating break.

Hardware Installation

Unpacking

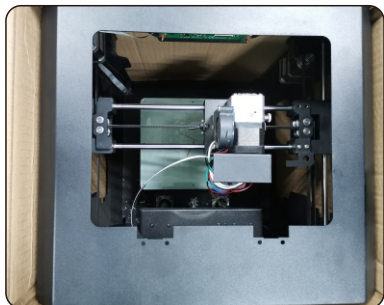

Unpacking



Turn on printer

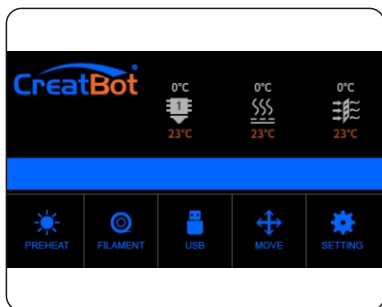

Turn on printer

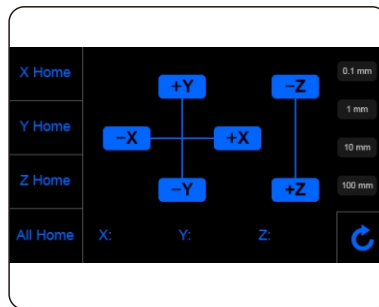

Up platform



1. Ensure the packing is not broken.
2. Need two people at the same time.
3. Lift it out by grasping the frame, not the belt or rails.
4. Turn on the printer, enter "Move axis" menu, select "All home", the bracket will rise, now you can takeout filament.

Printer Operation

Leveling Platform

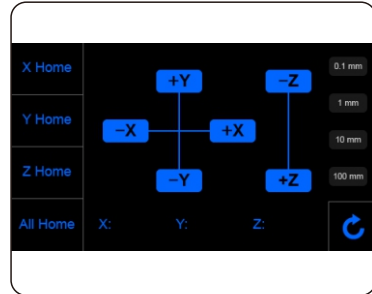

1. Turn on machine
2. On touch screen, choose "Move axis" -> "All home", make nozzle close to platform.
3. Move the extruder by hand to 4 corners and focus on the distance between the nozzle and platform. The distance 0.2mm (1 piece of name card distance) is suitable.
4. If not suitable, please rotate knob to make platform up or down a little to correct distance.
5. All the leveling nut should uniform, nozzle can't too close to the platform.
6. All will be subject to the actual effect of print, please make more little adjust at the beginning of printing.

Paving Masking Paper



Platform need paste masking paper or solid glue to achieve best viscosity, and the model will be firmly fixed on the platform.

Printer Operation

Load Filament

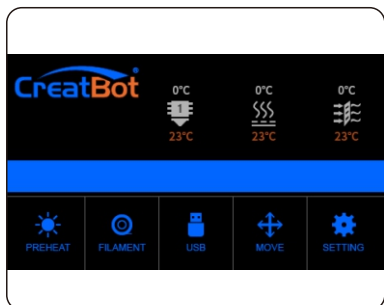

Preheat head

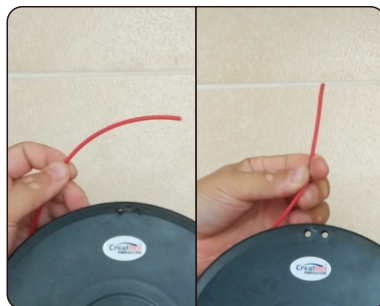

Straightened filament

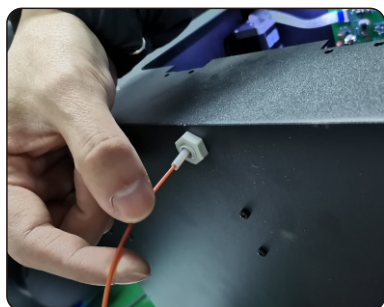

Load filament

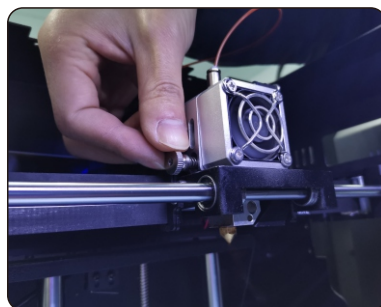

Tighten the nut

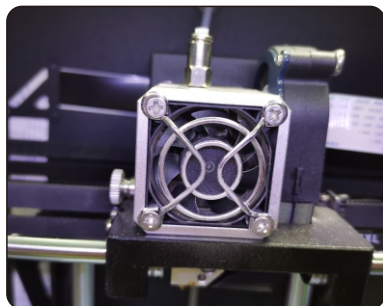

Load filament

1. Preheat the head you want load filament.
2. Straightened filament and check the filament is not self-winding.
3. Insert the filament to the inlet and push it to the nozzle, until melted and flowing naturally.
4. Tighten the compression nut, tightness is "back a circle after firmly" is appropriate.



Notice: Pressed filament too tight or too loose will affect normal wire feeding.

Printer Operation

Unload Filament

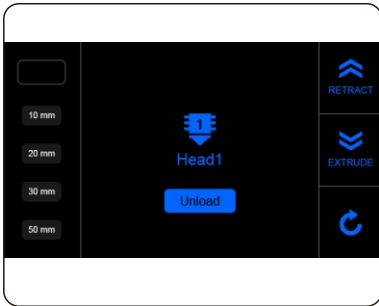

Unload filament menu

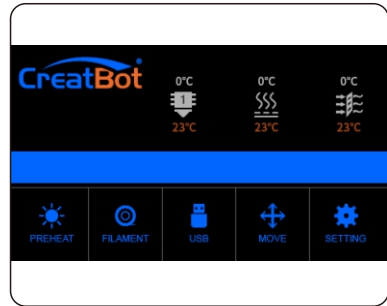

Preheat head

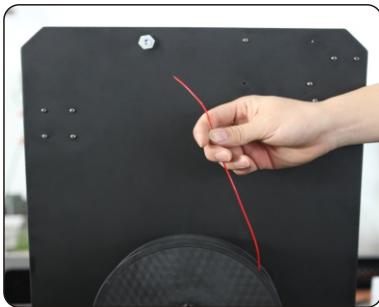

Pull out filament

1. Enter "Filament" menu -> "Unload filament", and select the head you want unload.
2. Wait for the nozzle heated to a suitable temperature.
3. After reaching temperature, feeder will send a certain number of filament, and then automatically withdraw filament.
4. To manually unload filament, same as above mentioned.

 *Warning: It is strictly prohibited without heating nozzle.*

 *Tip: If filament stuck in the guide tube, continue printing several lengths and retry.*

Printer Operation

Touchscreen

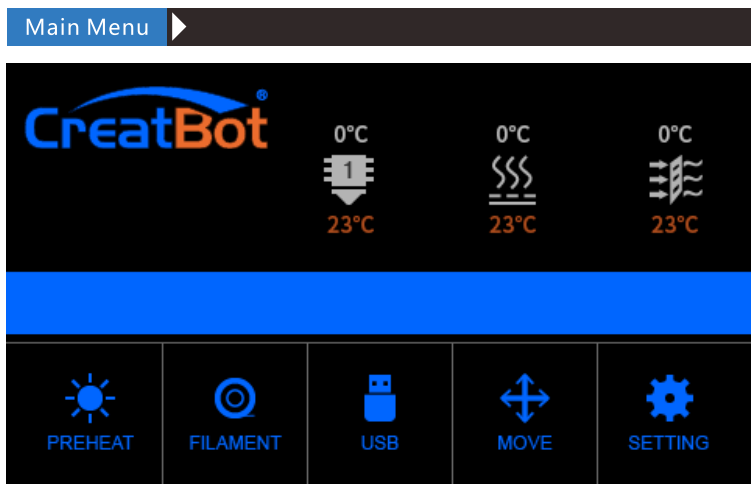

Preheat PLA



Cool down



Move axis



Filament menu



Resume



Setting



Open U-disk



USB unavailable



Z up



Pause



Stop



Z down

Printer Operation

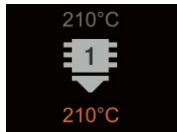
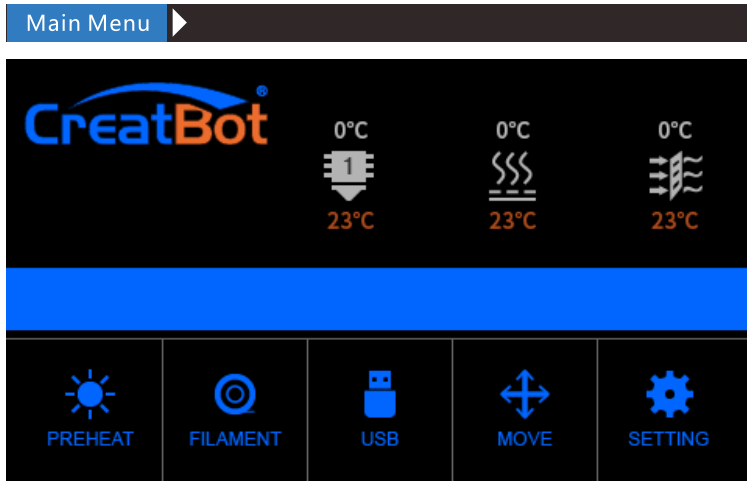

Touch and set up the temp of the nozzle.
210°C Preset nozzle temperature
210°C Current nozzle temperature

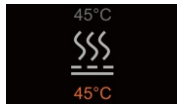

Touch and set up the temp of the hotbed.
45°C Preset platform temperature
45°C Current platform temperature

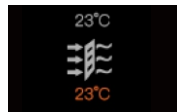

Touch and set up the temp of the Chamber.
23°C Preset Chamber temperature
23°C Current Chamber temperature

Printer Operation



Adjust. During printing, you can click it to adjust the print speed, fan speed and the extrusion.

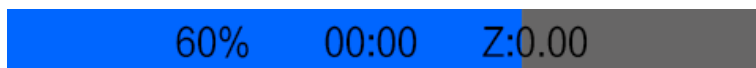

Current/ printing /progress



change



pause



stop

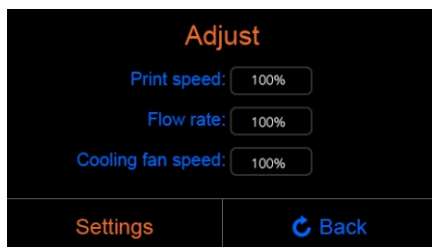

print speed: 100%
flow rate: 100%
colling fan speed: 100%

Printer Operation

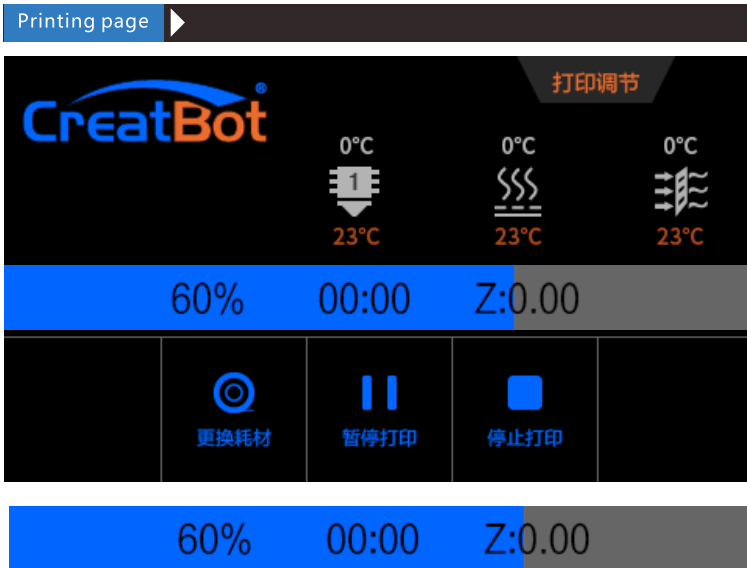

Current printing progress



Pause and Change filament.



resume



Pause print



Cancel print



bed up



bed down



The display will get darken when no operation in ten seconds and can be waken by clicking anywhere on the screen.

When the display shows the default print page, click anywhere except the buttons to turn back to the print details page.

Printer Operation

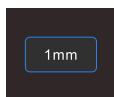
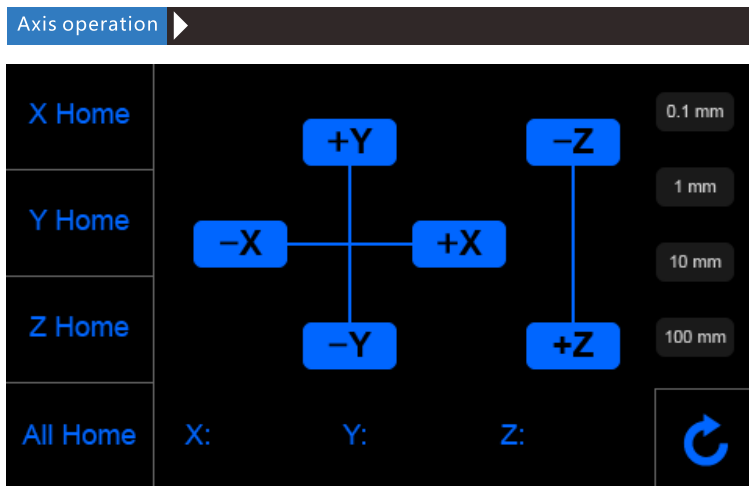

Minimum units



Move X to home



Move X/Y axis



Move Y to home



Z up

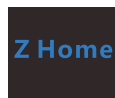

Move Z to home



Z down



All axis to home

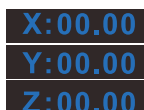

X,Y,Z current position of hotend.



Back

Printer Operation

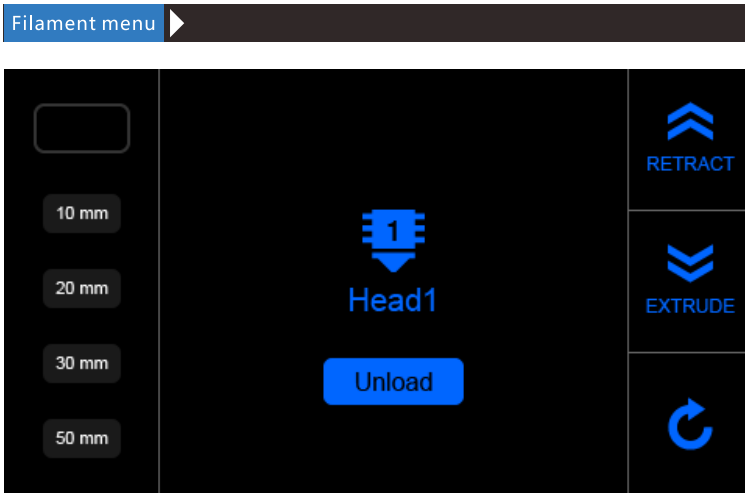

Click and enter a value



#1 extruder

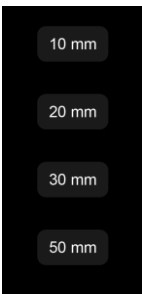

Adjust value when extrude/retract filament

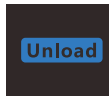

Retract filament



Extrude filament



Retract filament



Back



When you want to remove the filament, you need first to heat the extruder.

Printer Operation



Click and choose a file to print



Last page



Next page



Superior menu



Back

Printer Operation

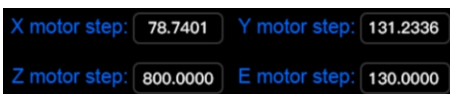
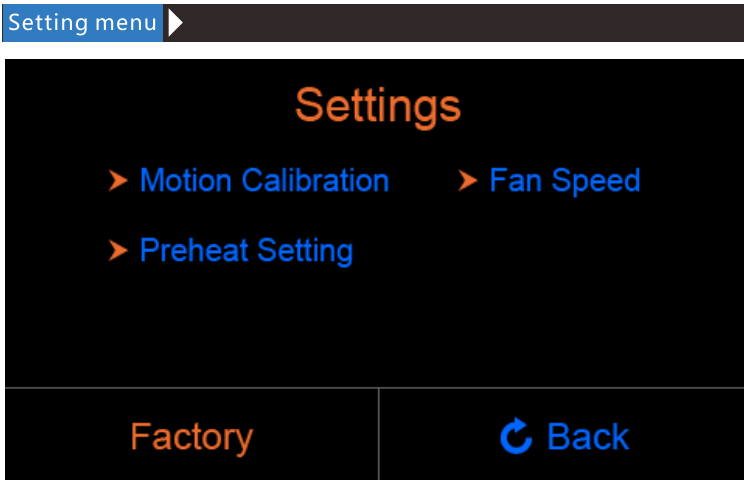

X/Y/Z and extruder motor setting (range:5-9999)



The values in the picture are not real values, the real values refer to the printer default values

Printer Operation

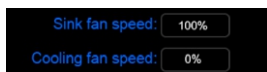
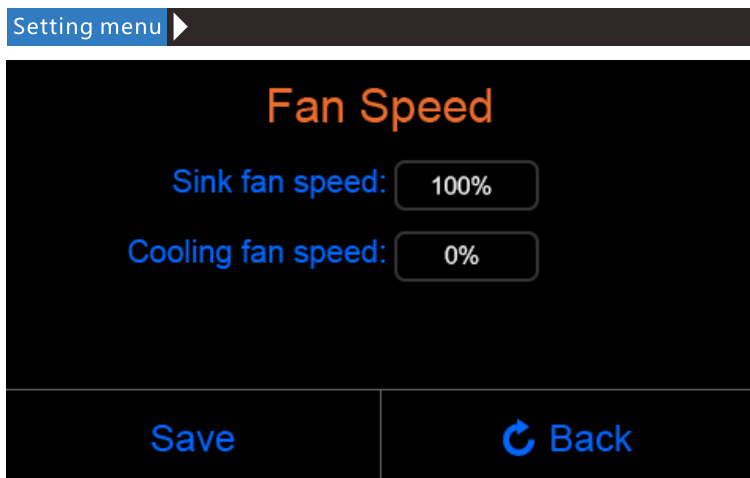

sink fan speed (range:1-100)
cooling fan speed (range:1-100)

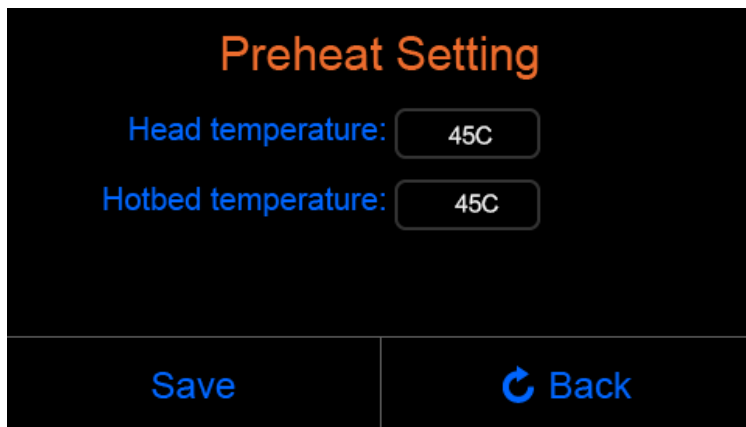

head temperature (range:0-420)
hotbed temperature (range:0-140)

Printer Operation



Time used
0000:00:00

Print time used

5.1.0

UI version

Firmware
6.1.XXXXXX

Firmware version



Back

Software Operation

CreatWare Setup

Download CreatWare installation package from the CD-ROM or www.CreatBot.com, follow the prompts to install the software, try using the default installation path as well.

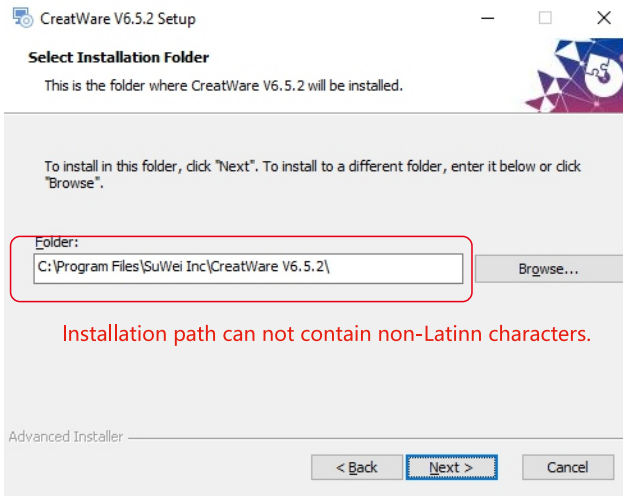

Please associated common 3D file format.

When there is a driver digital signature, please choose to agree. When finished the driver folder will locate at installation directory.

The software will select the correct language according to your OS, please select the right machine type and number of nozzles and ignore the other option and guide.

Software Operation

Quick Print UI



When insert SD card, the toolpath will saved to the SD card.

The file name can not contain non-Latinn characters.

Print Your First Model

Insert SD card to the card reader, open the CreatWare, load 3D model file[1], choose correct filament and option [2], finally click save button[3], you can now finish slice model.

Insert SD card to the printer, browse and select the Gcode file you just saved, the printer will automatically start to heating, when the temperature reaches, the printing will start.

Software Operation

Full Setting UI

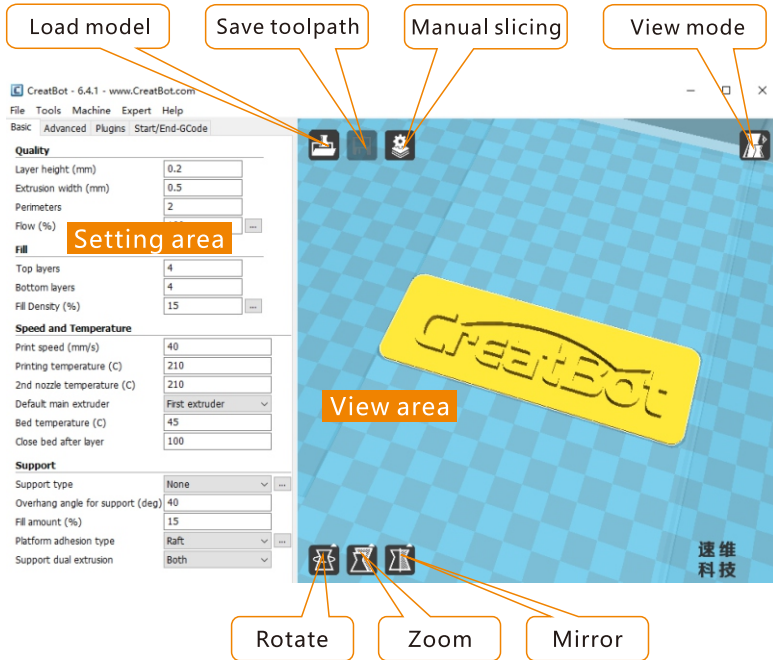

As you can see from the complete UI, the left side of the software is setting area, the right side is view area. The setting area contain "Basic", "Advanced", "Plugins", "Start/End GCode" four tabs. The Basic tab is the most common settings, usually the most frequently used parameters are here. Each parameter has a mouse-over tips, you can set parameters according to the prompt. If you want to restore the default settings, please click on the menu "Tools"-> "Restore Default".



Tip: Double-click view area can quickly load 3D model file. The view mode and edit icon will appear when you select the 3D mode.

Software Operation

Mouse Operation

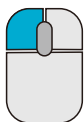

Left click

Select model, hold and move to change position, double-click to load 3D models.



Right click

Hold and move to rotate the viewpoint around the 3D model.

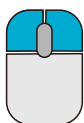

Left + Right

Hold and move the mouse to zoom.

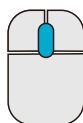

Scrollwheel

Use the scroll wheel to zoom in or out.

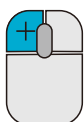

Left + Shift

Click and drag in rotary model can according to each 1 degree angle.

Shift

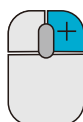

Right + Shift

Hold and move the mouse to pan the 3D view.

Shift

Keyboard Shortcut

Ctrl+L Load model/Picture

Ctrl+S Save model as

Delete Remove model

F5 Refresh view area

Ctrl+E Export setting

Ctrl+, Preferences

Software Operation

Model Rotate

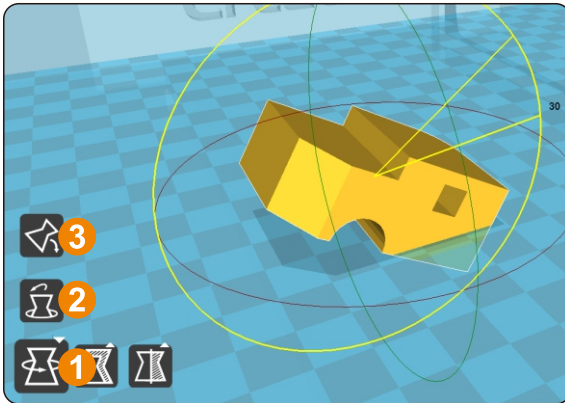

Click on the left corner of the rotate button [1], you can see three ring line around the model, respectively along the X, Y, Z direction. The default rotation angle is 5 degrees, press the Shift key can restrict the rotation angle to 1 degree.

Button [2] is the reset button, can restore rotate status to the default state.

Button [3] is lay flat button, can lay the model flat on the platform automatically.

Model Scale

Click the left corner of the zoom button [1], you can see a contour line around the model, and shows the current size of the model. You can input the value of the zoom ratio in Scale X / Y / Z , may also directly enter the size you need. Button [4] indicates locking scaling.

Button [2] is zoom reset button, you can restored the model to the default size.

Button [3] for the zoom model size to the maximum print size.

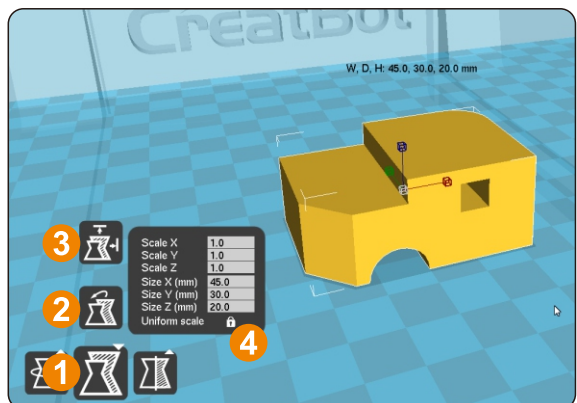

Software Operation

Right Click on Model

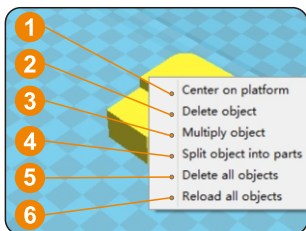

Right-click on the model pop-up shortcut menu, here are more features:

[1] "Centered" make the model back to the center position of the platform. [2] "Delete" to remove the currently selected model. [3] "Multiply" to copy the currently selected model and automatically position, which is useful for printing more than one model at a time. [4] "Split" multi-component model can be split into its separate components, this process more time-consuming, try to split the model in the modeling software, models splited can be printed individually and then assembled together. [5] "Delete All" to delete all the models loaded. [6] "Reload all" Reload all models, same as F5.

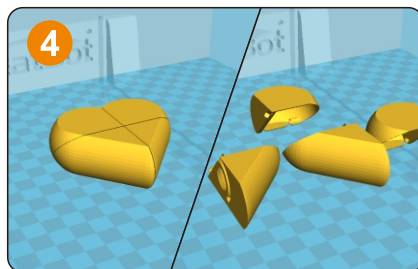
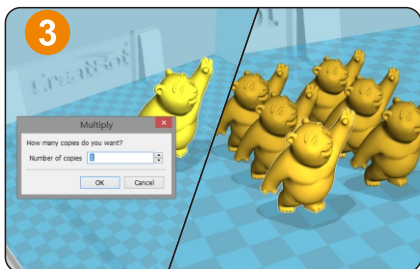

Toolpath Structure

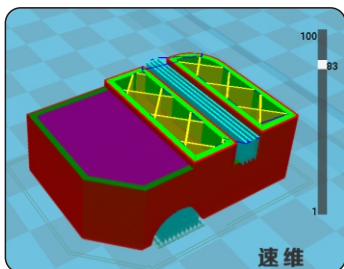

- Red represents "outer shell"
- Yellow represents "infill"
- Green represents "inner shell"
- Blue represents "support"
- Purple represents "bottom and top shell"

Drag layer indicator can browse different level paths, Ctrl + arrow keys to browse layer by layer. 3D printing is the superposition of these different layers and built layer by layer.

Software Operation

Model Mirror

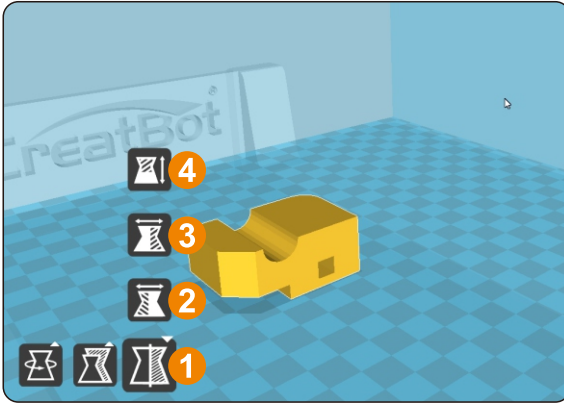

Click the mirror button [1], you can pop up the mirror menu.

Button [2] is a mirror along the X axis.

Button [3] is a mirror along the Y axis.

Button [4] is a mirror along the Z axis.

Note that the mirror transformation is different from the rotation, such as the mirror transformation will lead to a change in the direction of rotation, and the rotation will not change the model.

View Mode

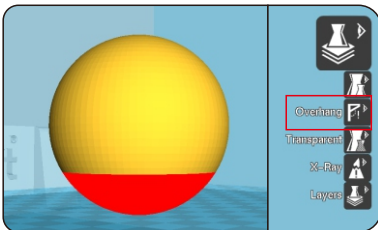

From the overhang view, you can see the suspended part of the model which is shown in red color. By changing the supporting angle can be seen suspended parts size is dynamically changing.

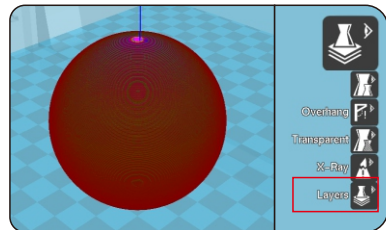

By slice view can easily observe the generated path, you can easily observe the different layers of sliced by slicing altitude indicator, use Ctrl + arrow keys can also be observed layer-by-layer.

Software Operation

Basic Setting

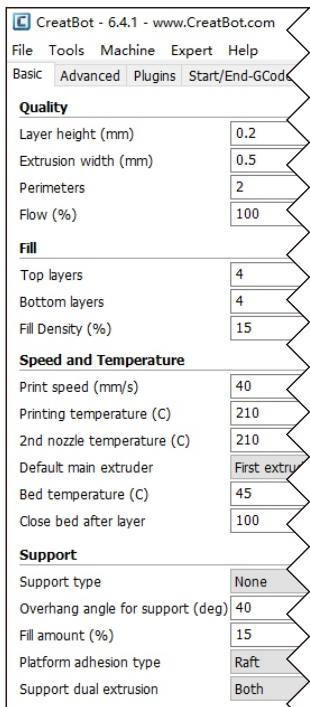

Layer height: This is the most important setting to determine the quality of your print, maximum value not exceed 80% of the nozzle diameter.

Shell thickness: Refers to the total thickness of the inner and outer walls, the outer wall is only one, the inner wall can be more, set this value to an integer multiple of the diameter of the nozzle.

Flow: Refer to the amount of printing material, 100% standard dosage, the more material the model prints more plump.

top/bottom thickness: Is the thickness of the upper and lower models, usually a multiple of layer height.

Fill density: Control how density filled the insides of your print will be, a value around 20% is usually enough, 0% for hollow.

Print speed: Speed at which printing happens. Print speed is affected by many factors, it is recommended to use low speed for complex model, high speed will cause the feed shortage, need improve nozzle temperature to compensate.

Nozzle temperature: Is the melting temperature of filament, general use 200°C for PLA and 240°C for ABS.

Bed Temperature: General use 45°C for PLA and 70°C for ABS.

Default main head: The default is the first nozzle, can also be set to other nozzles, this can reduce the times of changing filament.

Support type: The touching build plate support type is shown in figure [A], everywhere support is shown in figure [B].

Support angle: The larger the angle, the more support generate.

Fill amount: The larger the fill, the more support generate.

Platform adhesion type: The model which is not easy adhesion

on the platform please use Brim, which easy to warped or ABS filament please use Raft.

Support Type

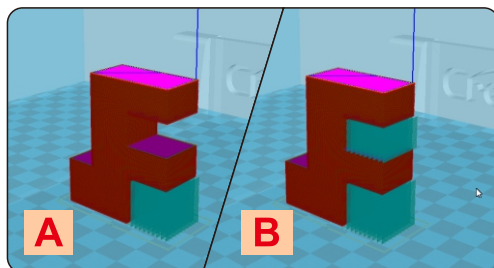

Software Operation

Advanced Setting

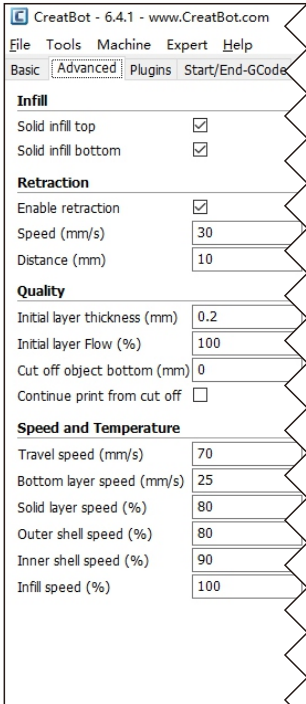

Solid fill top: Refers to whether to print the top surface of the model, uncheck will print it with infill method.

Solid fill bottom: Same as above, and so on.

Spiralis print: Refers to the method of spiral printing the outer wall of the model (single layer), and this feature is very suitable for print glass vase model.

Enable retraction: When the nozzle is moving over a non-printed area, withdraw a certain length length filament to prevent overflow.

Retract speed: The speed of retraction, too fast can lead motor out of step, too slow increase printing time.

Retract distance: The length of the filament when enable retraction.

First layer thickness: Height of the first layer of printing, generally greater than 0.15mm. □

First layer flow: When the set of the first layer is too high, it can be appropriate to increase the extrusion.

Cut off object bottom: This can be used for objects that do not have a flat bottom.

Continue print: Being "power outages continued" be substituted.

Travel speed: The speed when moving over a non-printed area.

First layer speed: Slightly slow speed can enhance adhesion

model on the platform.

Solid layer speed: The speed is a percentage here, which reference to the global print speed, a combination of different speeds, you can both get a good print quality and a faster print time.

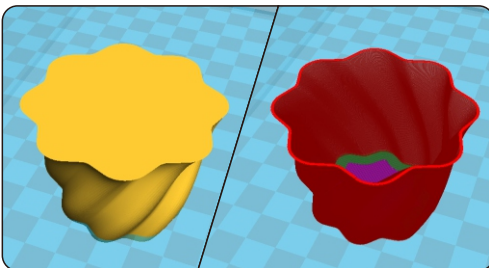

Spiralise Printing

Software Operation

Export Setting

Nozzle size: Set the nozzle size.

Diameter: Accurate measurement of your filament gives better quality prints.

Minimum travel: The minimum distance which can trigger filament retract.

Minimum extrusion: The minimal amount of extrusion that needs to be done before retracting.

Enable combing: Combing is the act of avoiding holes in the print for the head to travel over.

Wipe tower: Is a small tower next to your print where the nozzle wipes itself clean when switching nozzles.

Dual extrusion switch amount: Amount of retraction when switching nozzle with dual extrusion, a value of 15mm seems to generate good results.

Cooling fan: The extra cooling fan is essential while printing small model, but when print ABS material, the max fan speed should not more than 50%.

Skirt: The skirt is a line drawn around the model at the first layer. This helps to prime your extruder, and to see if the model fits on your platform.

Brim: The amount of lines used for a brim, more lines means a larger brim which sticks better.

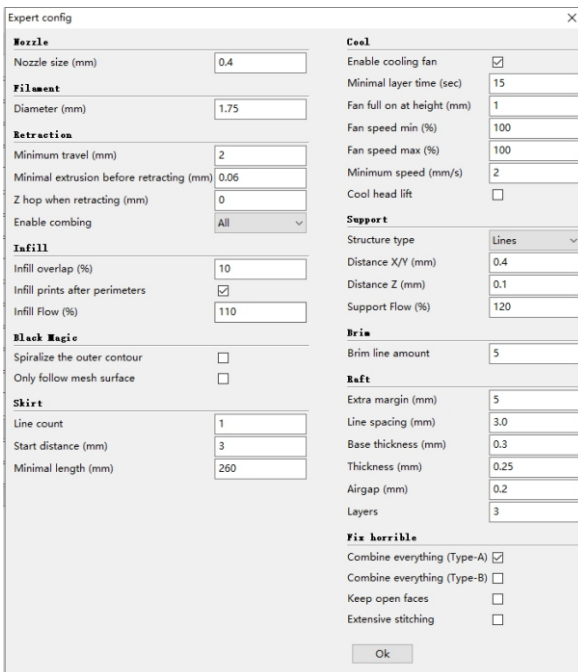

Notice: Most of the setting have been optimized, If you want restore default configuration, use the menu "Tools" -> "Reset profile to default".

Software Operation

Skirt · Brim · Raft

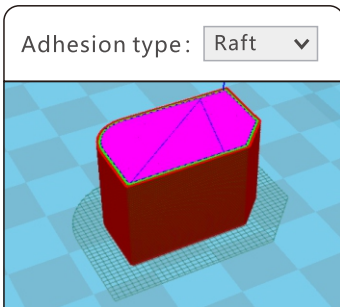
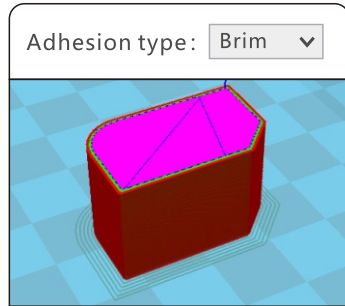
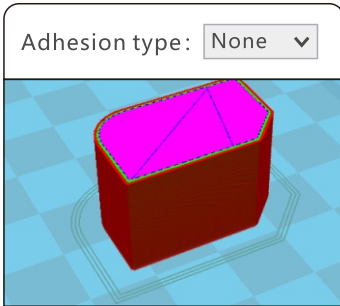

Plugin enable you to easily include your own features, without having to modify the source code or Gcode. In the screen shot above, these can be enabled by clicking on the arrow down button, then you can configure the plugin.



Notice: Please remove the plugin before you close the software.

Plugins

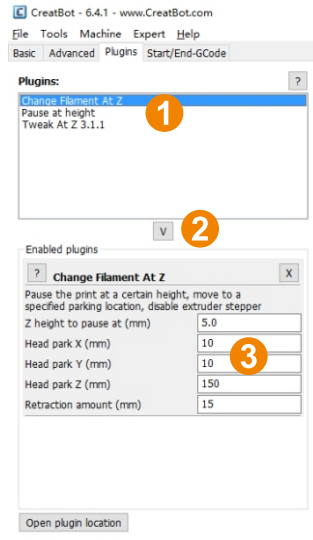

Software Operation

Start / End GCode

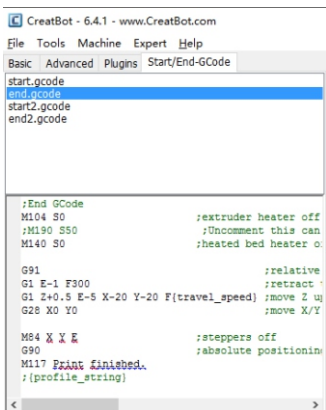

The start and end gcode are the startup and end procedure of the print, editing this requires knowledge of GCode.

If you want to set the automatic heating station after printing, you can remove the ";" in the code ";M190 S50".

start.gcode is the start code of single extruder, start2.gcode is the start code of double extruder, and so on.

Dual Head Printing

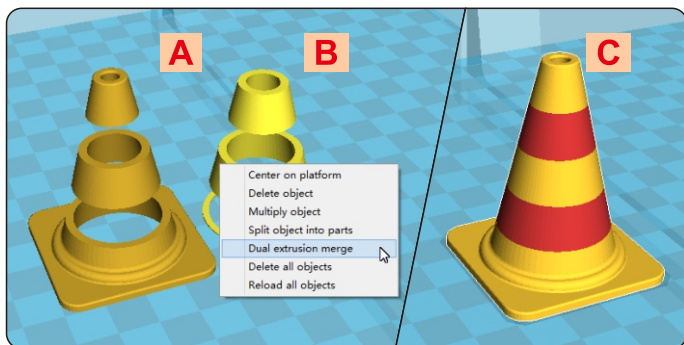

Step 1: Load 2 models you want as shown in figure [A] and [B].

Step 2: First click [A], then right click on [B], you will get the option: dual extrusion merge, this will merge both models into

one model [C].

Step 3: Set parameters like ordinary single color model and save the GCode.



Tip: The model select first will print by main extruder, the right clicked one by second extruder.

Software Operation

Add Multi Type Printer

You can add more than one type of CreatBot to the software, and easily switch between them without re-config all the different machine settings.

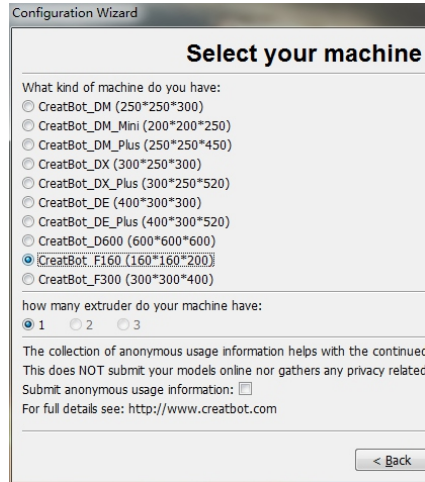
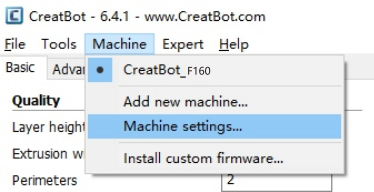

Using skills

Print Setting Of Different Filament

	Nozzle temperature	Hot bed	Plantform adhesion type	Fully enclose or not
PLA	190~210°C	None/45°C	None/Raft	Can open
ABS	240~260°C	90°C	Brim/Raft	Enclosed
Nylon	240~270°C	100	Brim/Raft	Enclosed
HIPS	230~260°C	100°C	None/Brim	Enclosed
PETG	230~260°C	100°C	None/Brim	Enclosed
Flexible	210~230°C	None/45°C	None	Can open
Wood	190~220°C	None/45°C	None	Can open
PC	230~260°C	100°C	Brim	Enclosed
PEEK	380~430°C	Bed 120°C/Air 70°C	None	Enclosed

* The data is only for reference, different environmental data will be different. F160 and F430 can print PEEK.

Using skills

Change Fuse



Open fuse tray



Change new fuse

Routine Maintenance

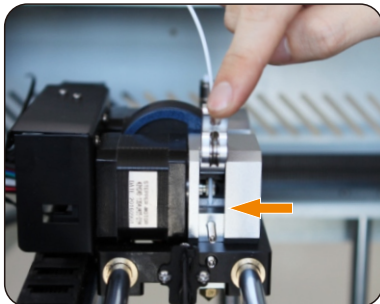
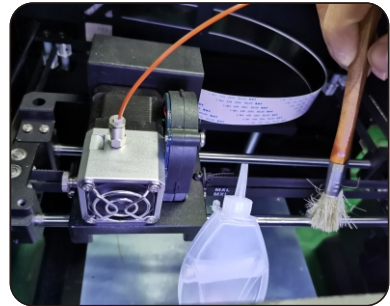
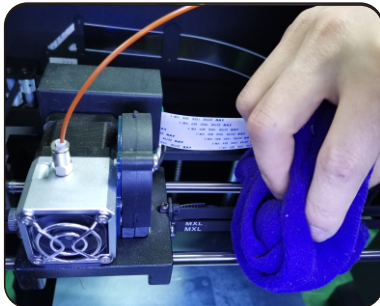

1. Frequent cleaning stains on the rail.
2. Lubricate the four guide rail.
3. Frequent cleaning feeder gear.



Notice: Don't add too much lubricating oil.

Using skills

Installation section

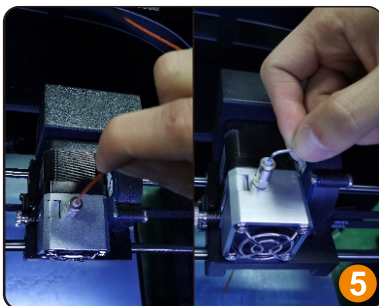
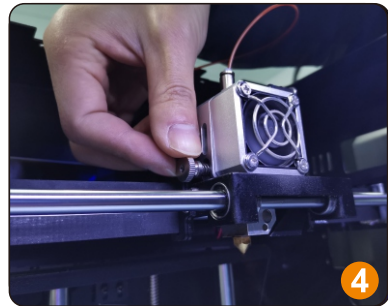
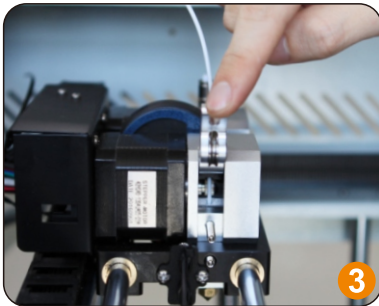
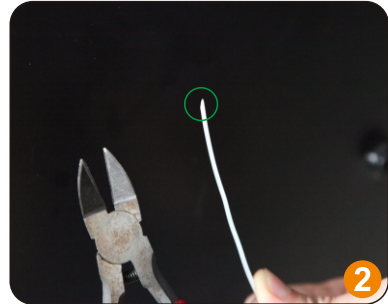
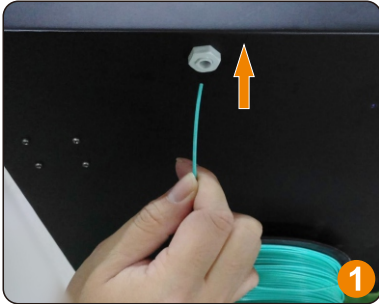

1. Better to use printed spool holders. According to curl direction of filament, Get filament through guide tube can prevent winding filament.

2. After preheating nozzle, Sharpen and straighten filament head is necessary. This will get filament through extruder easily.

3. if you can't send filament through nozzle well, remove pressure nut and

pressure spring first. Then open pressure arm and clear filament scrap. Sight guide hole and send filament well.

Skills of printing PEEK filament

1. Software setting details below.

1) Narrow the distance between the nozzle and working plate smaller than printing other normal filament, such as PLA.

2) **Layer height**

0.1mm -0.15mm. 0.2mm layer height is not suggested.

3) **Platform adhesion type**

To avoid warping, please add **"Raft"** as platform adhesion type, and then set the airgap 0.1~0.15mm (0.12mm better), layers at least **4** and extra margin at least 3mm. See picture below.

4) **Printing temperature** sets 400-420 degrees.

Bed temperature sets 100-150 degrees.

Printing speed 15mm/s-30mm/s. Please don't over 30mm/s, or will not extrude good.

Fill density 50%-90%.

Close the cooling fan during printing

(This is important, otherwise PEEK don't crystallization well)

If print small part, suggest set the cooling fan speed at 50%.

2. Preparations and skills

1) Take down the printed fan scooper before printing PEEK filament.

See picture below. (If your printer already takes down the fan scooper, please skip this step.)

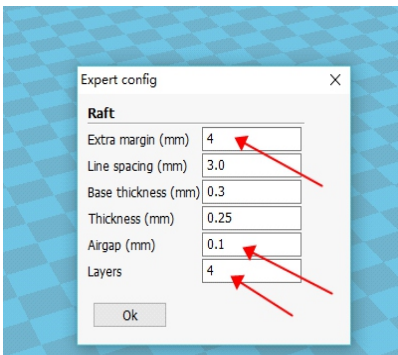

- 2) Suggest use PEI board or Carbon fiber board on working plate.
If use Carbon Fiber board,
please paint enough solid glue on it and dry it a little bit before
printing.
- 3) If long time will not use peek filament, please put away the
opened peek filament in the box.
- 4) Tighten up the spring nut in filament feeder to make sure the
PEEK filament silk successfully. Do filament silk test firstly to check
whether filament can be extrude fluently or not. And then focus on
the first layer which needs to be flat enough.
- 5) PEEK filament is easily loose from filament rack because of its
hardness during printing. We usually put it in the box. Attached a picture.
- 6) When you finish the print, please silk the PEEK filament remnants out
completely to avoid carbonization and blockage inside nozzle.
- 7) Every time before printing PEEK , you should heat nozzle more than 400 °C
to extrude filament smooth. If you can't extrude it well, push the stick to
extrude PEEK pieces that inside nozzle. (do same like the photo).
Make sure PEEK extrude well before printing.

For some complex sample, if you cannot get perfect peek print, we suggest
simplify3d software. (Printing path is better on some special models)
Simplify 3D support 500% flow on Raft layers. That is helpful if you have
problem on sticking Raft to bed.

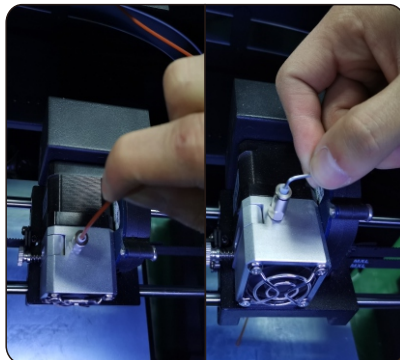

Frequently Asked Questions

Hardware Troubleshoot

1. Display "MINTEMP" ?

The environment is too low, or temperature control tube is damaged, please keep the room temperature above 0°C.

2. Display "MAXTEMP" ?

Temperature of nozzle or bed too high, or temperature control tube is damaged, please keep their temperature in a suitable range.

3. USB connection problems ?

Please specify the correct port and baud rate (250000), or change a shorter USB cable.

4. Nozzle heats up too slowly ?

Temperature in door is too low, or use a fan duct, or turn up output voltage (24.5v).

5. Print head stuck ?

Clean the guide rail and add lubricating oil.

6. Print head can not move ?

Stepper motor chipset burned, or belt damaged, or belt wheel screw loose.

7. Print head hit the framework ?

Corresponding axis stop limit or circuit fault.

8. Unable to power on ?

Power switch is damaged or fuse is burned, and please check whether the power adapter is working properly.

Printing Troubleshoot

1. How to set the temperature of the nozzle ?

Different filament temperature is different, general as follows:

PLA temperature 190°C ~210°C

ABS temperature 230°C ~250°C

You must leave enough time for filament heating, so the faster printing speed need the higher temperature, 60mm/s temperature need raise about 10°C. In the same way, larger thickness need higher temperature.

2. How to set the temperature of the hot bed ?

The main purpose of the hot bed is to prevent model wrapped, PLA need about 45°C and 70°C for ABS is enough, but due to the environment and filament, we often need to increase the temperature, the highest temperature

4. Tighten pressure nut. (twist pressure nut 8~12 times after nut touch spring. Neither too loose, nor too tight)
 5. Extrude filament for a while and pull out quickly when you change filament. Otherwise, filament may block inside heatbreak. Or choose "Change Filament" on touch screen.
- Use the small stick to poke filament out if there are filament scrap block inside heatbreak or nozzle.

Software

1. If your machines are equipped with different diameter nozzle (default 0.4mm). You have to setting:
 - Expert-open expert setting... Nozzle size (same to yours)
 - Basic-Quality-Extrusion width (same to yours)
2. Small objects need lower hotend temperature around 190~200°C.
 - Large objects better to use Support-Raft. Easy to stick when start printing. Easy to remove when finish printing.

Adjust Z Limit

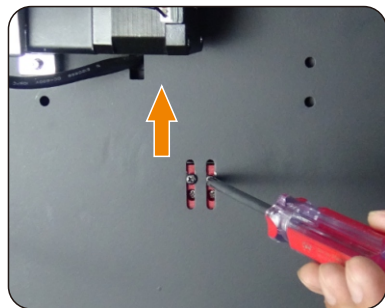
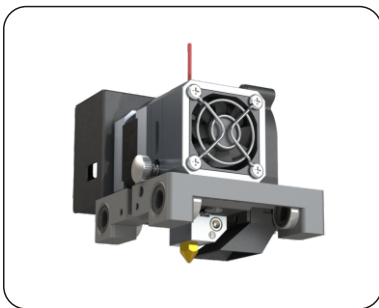

If the nozzle can't touch the platform even loosen all the leveling nut, you can move Z stop limit a little up, as you can see from figure.

Frequently Asked Questions

Printing Troubleshoot

not over 120°C, and you can close the bed above 100mm.

3. The model not stick on the platform ?

Please paste masking paper or Kapton on the platform, or the nozzle is too far away from the platform, or the bottom of the model is not flat.

4. No or less silk coming on the first layer ?

The distance between nozzle and platform is too small, or the filament has not been sent to the nozzle.

5. Why nozzle is not spit silk ?

The filament is not pressed or too tight, or print temperature is too low, or the filament feeder not working.

6. How to prevent model become warped ?

Increase hot bed temperature or use Kapton, or change platform adhesion type to Raft, or cover the baffle, or reduce indoor ventilation.

7. How far from nozzle to platform appropriate ?

Distance should be 0 in theory, but there is no absolute flat platform, so the distance should ± 0.1 mm. Finally, with the actual printing effect as the standard, too close will lead to a silk blocked, too far will cause the model not stick on the platform.

8. How to determine whether the temperature is too high ?

PLA temperature is too high will appear liquefaction, ABS will be the carbide, that will block the nozzle.

9. What reasons will causing nozzle blocked ?

Filament are impurities or print environment dust too much, bad of thermal conductivity between the nozzle and the heating block.

10. Model surface is loose with crack ?

The layer is too high or the printing speed too fast, nozzle temperature too low or filament press nut too loose, or filament is wrapped.

11. How to print a small model ?

Multiple the model, and print them at a time.

12. Dual color model not aligned ?

Adjust offset of second nozzle in machine settings.



13. Dual color model color interference ?

Align two nozzle in vertical direction

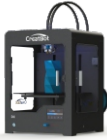

14. There is too much silk drag on the model ?

Please enable filament retraction, and specified proper retract speed, and distance, the retract distance should not less than 4mm, and the speed not less than 10mm/s.

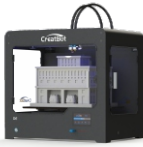
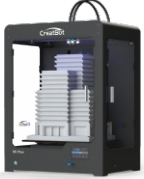

Specifications

				
Model	DX	DX Plus	DE	DE Plus
Single Extrusion	300*250*300	300*250*520	400*300*300	400*300*520
Dual Extrusion	280*250*300	280*250*520	380*300*300	380*300*520
Triple Extrusion	260*250*300	260*250*520	360*300*300	360*300*520
Nozzles	Dual/Tris			
Diameter	0.4mm(0.3/0.6/0.8/1.0mm can be customized)			
Temperature	350 °C			
Nozzles Type	print head/new print head			
Hot bed	100 °C (can be closed after certain layers)			
Min. Layer	0.04mm			
Accuracy	X、Y、Z axis 0.05mm			
Print Speed	40-120mm/s (inner/outer, top/bottom, fill, first layer speed can be setting)			
Travel Speed	200mm/s			
Materials	ABS,PLA,TPU,PETG,HIPS,PVA, PA,PC,Carbon Fibre,etc			
Fila. Diameter	3.0mm (1.75mm optional)			
Auto Turnoff	Yes (pwr manager + relay)			
Continue Play	Yes (Power outage, lower plate and save data)			
Fila. Check	Yes (pause printing when filament finish, and lower platform)			
Adju. Head	Yes (height-adjustable-nozzles)			
OS	Windows, Mac OS			
Languages	Chinese, English multi-language			
Software	CreatWare Muti-language			
File Format	STL, OBJ, GCode, Amf			
Chipset	Atmega 2560-16AU (AVR 8 Bit 16MHz , 256KB Flash)			
Display	4.3 inch touch screen			
Pwr Supply	110/220V 360W		110/220V 700W	
Dimension	420*380*570	420*380*790	590*430*570	590*430*790
Weight	35 Kg	40Kg	45Kg	55Kg

Specifications

			
Model	F160	F430	D600
Build volume	160*160*200	400*300*300	600*600*600
Dual Extrusion		320*300*300	540*600*600
Nozzles	Single	Dual	
Diameter	0.4mm(0.3/0.6/0.8/1.0mm can be customized)		
Temperature	260°C (support max 420 °C)		350 °C
Nozzles Type	Direct drive		
Hot bed	140°C	Bed 120°C/Air 70°C	100°C
Min. Layer	0.01mm	0.02mm	0.05mm
Accuracy	X、Y、Z axis 0.05mm		
Print Speed	120mm/s (inner/outer, top/bottom, fill, first layer speed can be set separately)		
Travel Speed	200mm/s		
Materials	ABS,PLA,TPU,PETG,HIPS,PVA, PA,PC,Carbon Fibre,PEEK,etc		
Fila. Diameter	1.75mm		3.0mm
Motion Structures	Optic axis	guide rail	Rectilinear orbit
Auto Turnoff	Yes (pwr manager + relay)		
Continue Play	Yes (Power outage, lower plate and save data)		
Fila. Check	Yes (pause printing when filament finish, and lower platform)		
Adju. Head	Yes (height-adjustable-nozzles)		
OS	Windows, Mac OS		
Languages	Chinese, English multi-language		
Software	CreatWare Muti-language		
File Format	STL, OBJ, GCode, Amf		
Printing Field	Full closed covering		
Display	4.3 inch touch screen		
Pwr Supply	110/220V 180W	110/220V 1300W	110/220V 1000W
Dimension	280*280*470mm	660*470*560mm	910*840*1100mm
Weight	22Kg	60Kg	170Kg

Specifications

		
Model	PEEK-300	F1000
Build volume	300*300*400mm	1000*1000*1000mm
Dual Extrusion	240*300*400mm	940*1000*1000mm
Nozzles	Double	
Diameter	0.4mm(0.3/0.6/0.8/1.0mm optional)	1.0 mm (0.4~1.5 mm)
Temperature	Max 500°C	Max 420°C
Hot bed	Max 200 °C	Max 100°C
Min. Layer	0.05mm	0.05mm
Accuracy	X.Y0.011mm;Z 0.025	X.Y0.011mm;Z 0.025
Print Speed	10-150 mm/s	10-120 mm/s
Materials	ABS,PLA,Carbon Fiber,PETG,Nylon,PC,etc.	
Fila. Diameter	1.75 mm	
Auto Turnoff	Yes (pwr manager + relay)	
Continue Play	Yes (Power outage, lower plate and save data)	
Fila. Check	Yes (pause printing when filament finish, and lower platform)	
Adju. Head	Yes (height-adjustable-nozzles)	
OS	Windows, Linux, Mac OS, OSX	
Languages	Chinese, English	
Software	CreatWare Muti-language	
File Format	STL, OBJ, GCode, Amf	
Chipset	Atmega 2560-16AU (AVR 8 Bit 16MHz, 256KB Flash)	
Display	4.3 inches color touch screen	9.7 inches color touch screen
Pwr Supply	200V~240V, 20A	220~240 V, 50~60 Hz;4000W
Dimension	650*600*750 mm	1910*1510*2205mm
Weight	100 kg	640 kg



Quality · Experience · Service

Henan Creatbot Technology Limited

Telephone: +86 4000-558-930

Website: www.CreatBot.com

Email: sales@creatbot.com

Address: 6#, Chaoya Industry Park,
Hanghai Road, No.13 Ave.,
Eco-Tech Development Zone,
Zhengzhou City, Henan Province, China