

# CreatBot 3D Printer

## User manual

English V7.4

# CONTENTS

Notice .....	3	Model Rotate/Scale .....	27
Machine Diagram		Model Mirror .....	28
Font and back .....	4	View Mode .....	28
Filament Feeder .....	5	Right Click on Model .....	29
New Printer Head .....	6	Toolpath Structure .....	29
Hardware Installation		Basic Setting .....	30
Unpacking .....	7	Advanced Setting .....	31
Install Build Platform .....	8	Expert Setting .....	32
Install Feeder .....	9	Skirt/Brim/Raft .....	33
Leveling Platform .....	10	Plugins .....	33
Paving Masking Paper .....	10	Start/End GCode .....	34
Load Filament .....	11	Dual Head Printing .....	34
Change Filament .....	12	Align Dual Head Horizon ...	35
Printer Operation		Align Dual Head Vertical ...	36
Main menu .....	13	Add Multi Type Printer .....	36
Detail page .....	15	Print Different Filament ...	37
Printing page .....	16	Using skills	
Axis operation .....	17	Change Fuse .....	38
Filament menu .....	18	Routine Maintenance .....	38
SD Card/U-disk .....	19	Installation section .....	39
Setting menu .....	20	Software .....	40
Info. menu .....	22	Adjust Z Limit .....	40
Software Operation		Frequently Asked Questions	
CreatWare Setup .....	23	Hardware Troubleshoot ...	41
Quick Print UI .....	24	Printing Troubleshoot .....	42
Print Your First Model .....	24	Specifications	
Full Setting UI .....	25	Technical specs .....	43
Mouse Operation .....	26		



Tip icon to remind users to have a good method or technique.



Note icon, to remind the user must be given adequate attention.



Prohibition icons, prevents users from unauthorized operation.

9/10/2021

# Notice

## Read First

Thank you for choosing CreatBot 3D printer!

This manual contains important information about the installation, use, maintenance and common problems of CreatBot 3D printer. Please read this manual carefully before using 3D printer. All losses caused by the breach of the notes and the operation process of the operation process will be borne by the user. Please use the filament provide by CreatBot, or high quality filament by third manufacturers. Due to the use of third party inferior material caused by the failure of the printer, the loss will be borne by the user.

Software running environment, 2G or above processors, at least 1G memory, compatible with Windows, MAC, or Linux, please use memory as much as possible.

I wish you have fun with CreatBot 3d printer!

## Danger Warning



The nozzle's temperature will reach 300 degrees, don't touch.



The platform's temperature will reach 120 degrees, don't touch.



Please make sure that the printer connected to the ground.



Do not attempt to open the case, be careful of electric shock.

## Working Environment



The 3D printer can work in the indoor environment of 5 °C to 30 °C.



Long-term not use of the printer, be sure to dust, moisture.



Long-term not use of the filament, please be sealed to prevent deterioration.

# Machine Diagram

## Front and Back

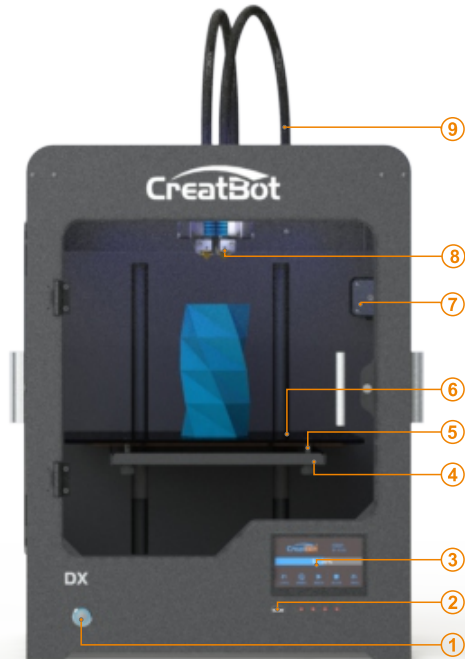

1. Power switch
2. U disk slot
3. Touch screen
4. Leveling nut
5. Leveling spring
6. Build platform
7. X stepper motor
8. New Printer head
9. Filament guide pipe

# Machine Diagram

## Front and Back

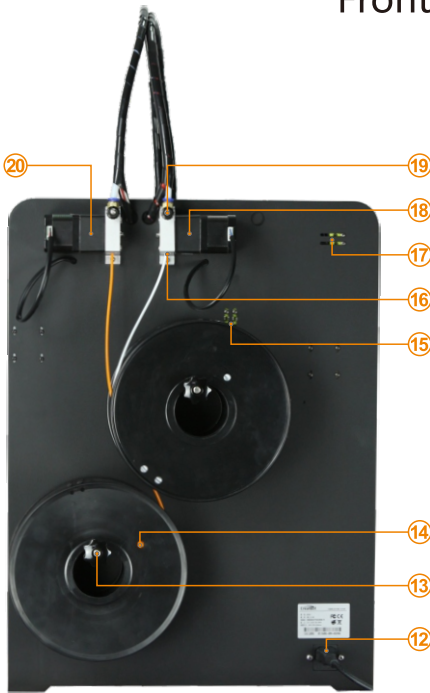

- 12. Power socket
- 13. Spool holder
- 14. Filament
- 15. Z stop limit
- 16. Filament inlet
- 17. X stop limit
- 18. Filament feeder 1
- 19. Compression nut
- 20. Filament feeder 2

## Filament Feeder

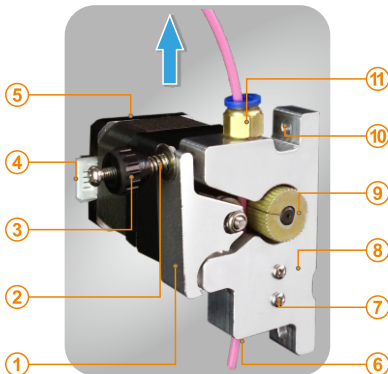

- 1. Pressure arm
- 2. Pressure spring
- 3. Pressure nut
- 4. Wire socket
- 5. Geared motor
- 6. Filament inlet
- 7. Filament sensor
- 8. Feeder body
- 9. Feeding wheel
- 10. Fixed hole
- 11. Pipe joint

# Machine Diagram

## New Printer Head

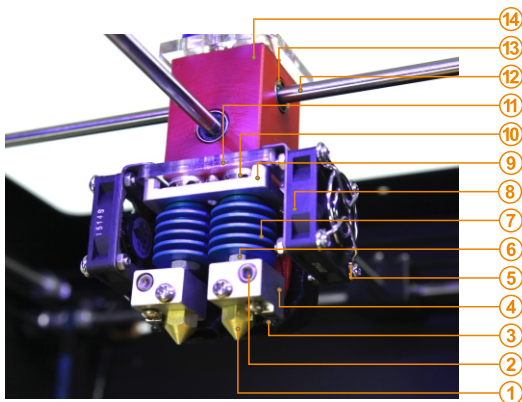

1. New Nozzle
2. New Heating tube
3. Thermostat tube
4. New Heating block
5. Fan duct
6. Heat Break
7. Heat Sink
8. Cooling fan
9. Head Al. frame
10. Head adjust
11. Adapter plate
12. Linear axis
13. Linear bearing
14. Head main block

# Hardware Installation

## Unpacking



Unpacking

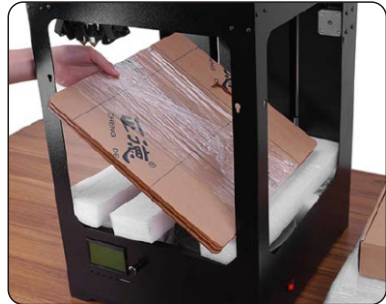

Take out accessories



Turn on printer



Take out filament

1. Ensure the packing is not broken.
2. Need two people at the same time.
3. Lift it out by grasping the frame, not the belt or rails.
4. Takeout the accessories, will see the bracket and the filament.
5. Turn on the printer, enter "Move axis" menu, select "Auto home", the bracket will rise, now you can takeout filament.



Tips: Press  same as "Auto home".

# Hardware Installation

## Install Build Platform



Take out platform



Install platform



Tighten the screws

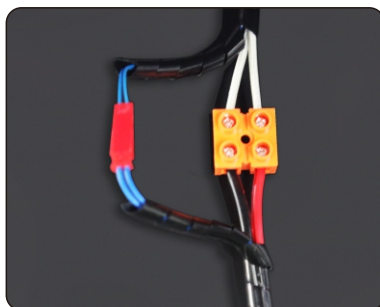

Connect the cables

1. Enter "Move axis" menu, move the platform a little down.
2. Fix the M5 screw to the hole of bracket, do not tighten.
3. Insert platform to the bracket, the bracket is between plate and tray.
4. Aim the tray fix hole to the M5 nut, then tighten the screws.
5. Connect the power plug and temperature sensor plug.



*Notice: Ensure the plug is well contacted.*



# Hardware Installation

## Install Feeder

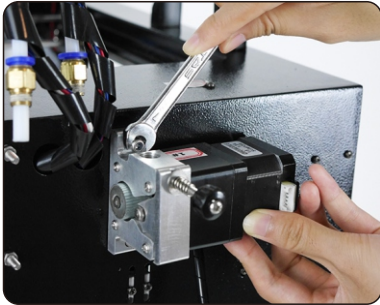

Fixed feeder

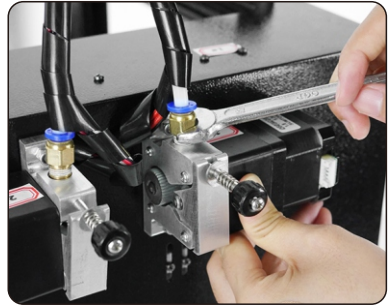

Connect joint

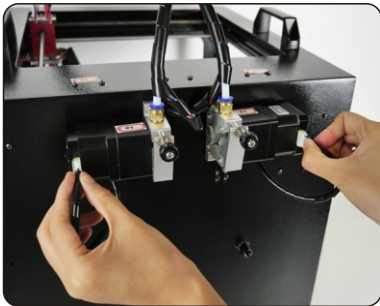

Plugin cable 1

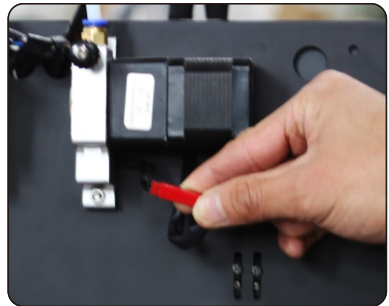

Plugin cable 2



Install spool's holders

1. Take out the feeder, pay attention to the order between left and right feeder.
2. Mount the feeder fixing hole on the back the chassis.
3. Tighten the screw nut firmly with a wrench.
4. Tighten the joint nut firmly on the feeder.
5. Plug in the motor cable to the socket and Connect the red filament detection cables.
6. Install spool's holders.
7. Install rack sleeve, you can download it



*Notice: Feeder must same order to the nozzle.*

# Printer Operation

## Leveling Platform

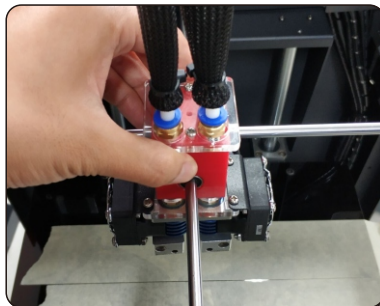
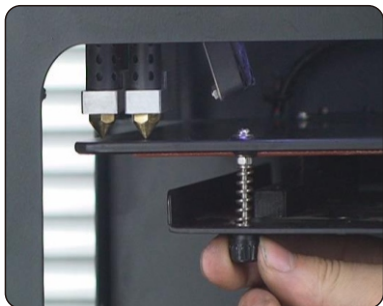

1. Turn on machine
2. On touch screen, choose "Move axis" -> "All home" , make nozzle close to platform.
3. Move the extruder by hand to 4 corners and focus on the distance between the nozzle and platform. The distance 0.2mm (1 piece of name card distance )is suitable.
4. If not suitable, please rotate knob to make platform up or down a little to correct distance.
5. All the leveling nut should uniform, nozzle can't too close to the platform.
6. All will be subject to the actual effect of print, please make more little adjust at the beginning of printing.

## Paving Masking Paper



Platform need paste masking paper or Kapton to achieve best viscosity, and the model will be firmly fixed on the platform.

Kapton is double-sided tape, please tear film on both sides.

# Printer Operation

## Load Filament

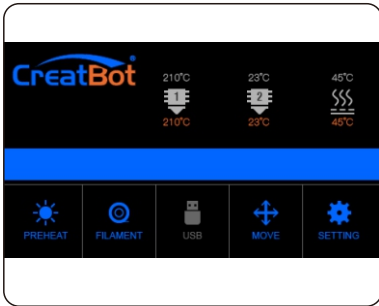

Preheat head

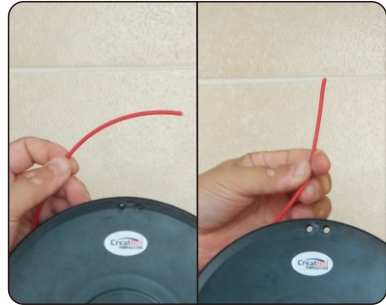

Straighten filament

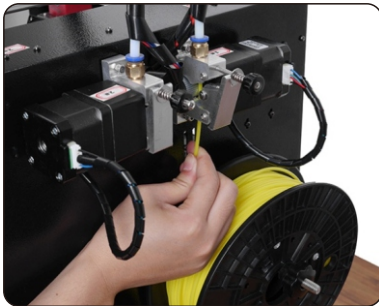

Load filament



Tighten the nut

1. Preheat the head you want load filament.
2. Straightened filament and check the filament is not self-winding.
3. Insert the filament to the inlet and push it to the nozzle, until melted and flowing naturally.
4. Tighten the compression nut, tightness is "back a circle after firmly" is appropriate.



*Notice: Pressed filament too tight or too loose will affect normal wire feeding.*

# Printer Operation

## Unload/Change Filament

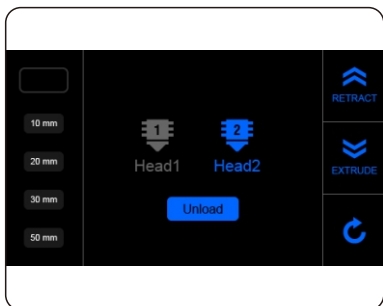

Unload filament menu

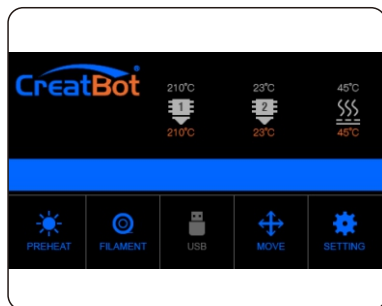

Preheat head

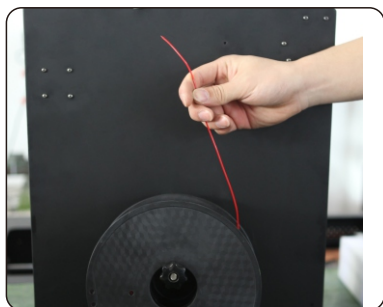

Pull out filament

1. Enter "Filament" menu -> "Unload filament", and select the head you want unload.
2. Wait for the nozzle heated to a suitable temperature.
3. After reaching temperature, feeder will send a certain number of filament, and then automatically withdraw filament.
4. To manually unload filament, same as above mentioned.



*Warning: It is strictly prohibited without heating nozzle.*



*Tip: If filament stuck in the guide tube, continue printing several lengths and retry.*

# Printer Operation

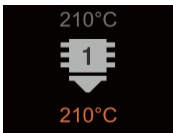
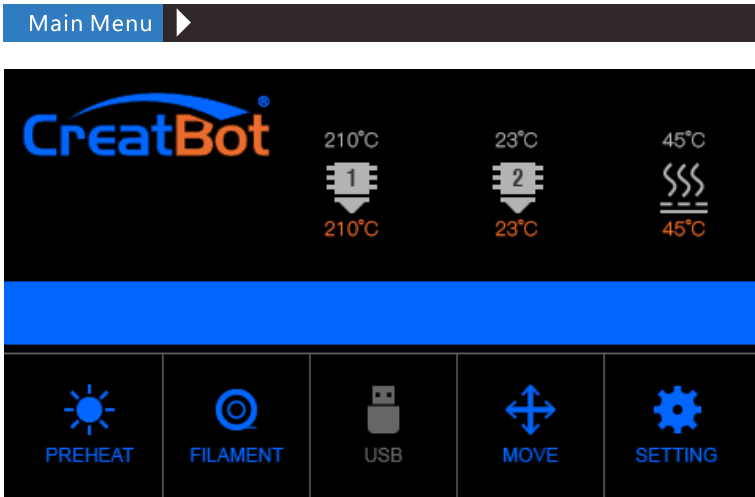

Touch and set up the temp of the nozzle.  
**210°C** Preset nozzle temperature  
**210°C** Current nozzle temperature

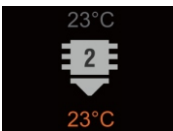

Touch and set up the temp of the nozzle.  
**23°C** Preset nozzle temperature  
**23°C** Current nozzle temperature

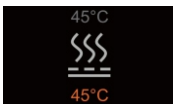

Touch and set up the temp of the hotbed.  
**45°C** Preset platform temperature  
**45°C** Current platform temperature

# Printer Operation Touchscreen

Main Menu ▶

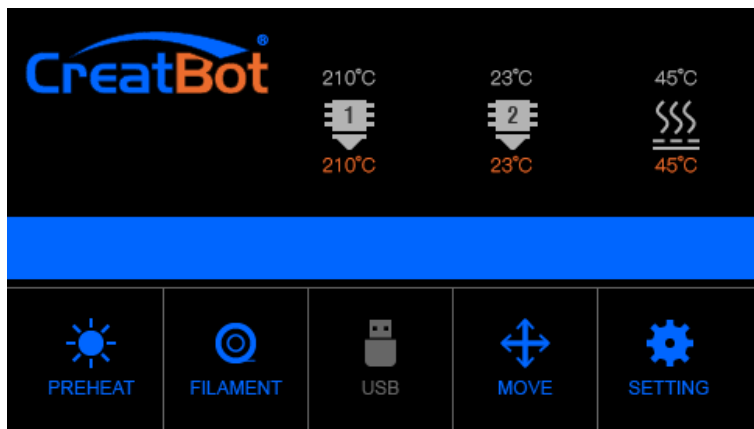

preheat



Cool down



Filament menu



Move axis

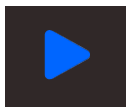

resume



Setting



Open U-disk



USB unavailable



bed up



pause



stop



bed down

# Printer Operation

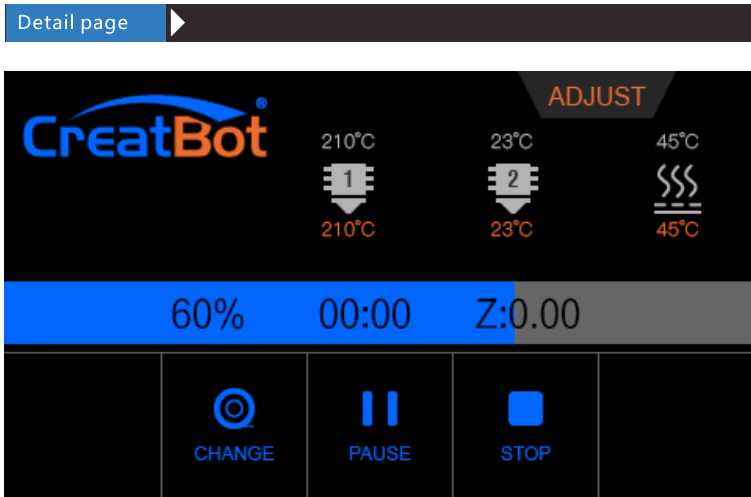

Adjust. During printing, you can click it to adjust the print speed, fan speed and the extrusion.



Current/ printing/ progress



change



pause



stop

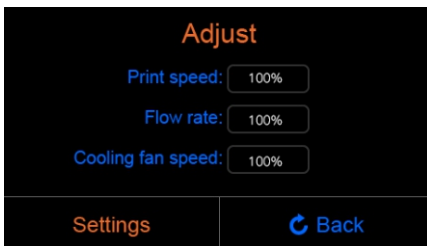

print speed: 100%  
 flow rate: 100%  
 colling fan speed: 100%

# Printer Operation

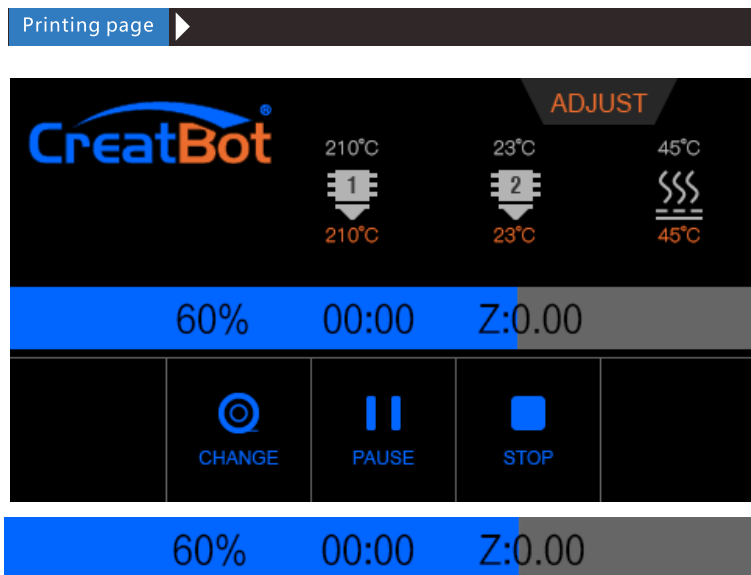

Current/ printing /progress



Pause and Change filament.



Continue printing



Pause print



Cancel print



bed up



bed down



*The display will get darken when no operation in ten seconds and can be waken by clicking anywhere on the screen.*

*When the display shows the default print page, click anywhere except the buttons to turn back to the print details page.*



# Printer Operation

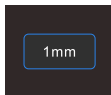
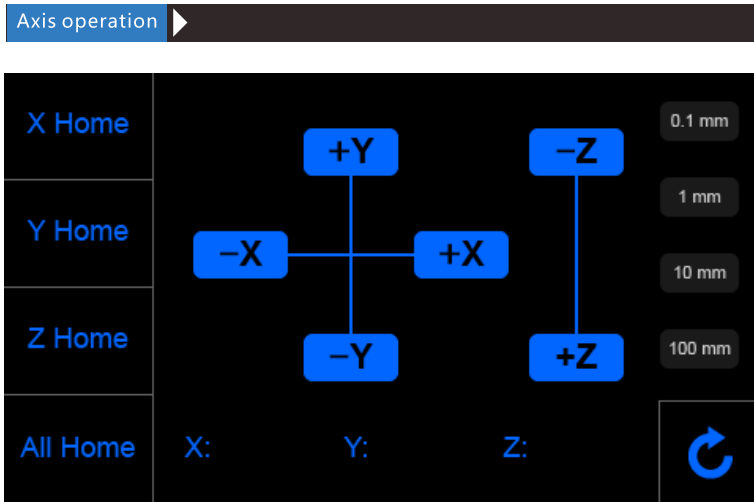

Minimum units



Move X to home



Move X/Y axis



Move Y to home



Z up

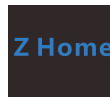

Move Z to home



Z down

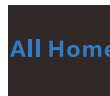

All axis to home

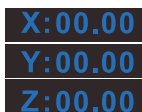

X,Y,Z current position of hotend.



Back

# Printer Operation

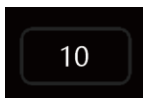
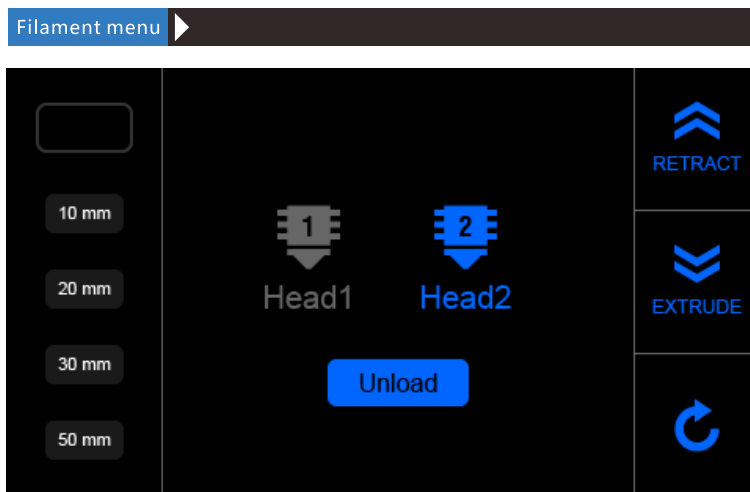

Click and enter a value



#1 extruder

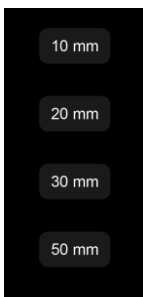

Adjust value when extrude/retract filament



#2 extruder (unavailable)

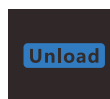

Retract filament



Extrude filament



Retract filament



Back



*When you want to remove the filament, you need first to heat the extruder.*

# Printer Operation



file1.gcode  
file2.gcode

Click and choose a file to print



Last page



Next page



Superior menu



Back



# Printer Operation

Setting menu ▶

## Settings

▶ Motion Calibration      ▶ Fan Speed

▶ Preheat Setting

---

Factory                      ↻ Back

## Motion Calibration

X motor step:     Y motor step:

Z motor step:     E motor step:

---

Save                              ↻ Back

X motor step:     Y motor step:     X/Y/Z and extruder motor setting (range:5-9999)

Z motor step:     E motor step:

Save                      Save                      ↻ Back                      Back

The values in the picture are not real values, the real values refer to the printer default values

# Printer Operation

Setting menu ▶

## Fan Speed

Sink fan speed:

Cooling fan speed:

Save ↻ Back

Sink fan speed:  sink fan speed (range:1-100)  
Cooling fan speed:  cooling fan speed (range:1-100)

## Preheat Setting

Head temperature:

Hotbed temperature:

Save ↻ Back

Head temperature:  head temperature (range:0-260)  
Hotbed temperature:  hotbed temperature (range:0-100)

# Printer Operation

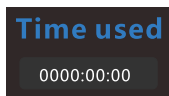

Print time used

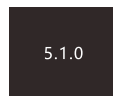

UI version

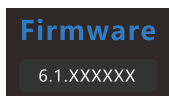

Firmware version



Back

# Software Operation

## CreatWare Setup

Download CreatWare installation package from the CD-ROM or [www.CreatBot.com](http://www.CreatBot.com), follow the prompts to install the software, try using the default installation path as well.

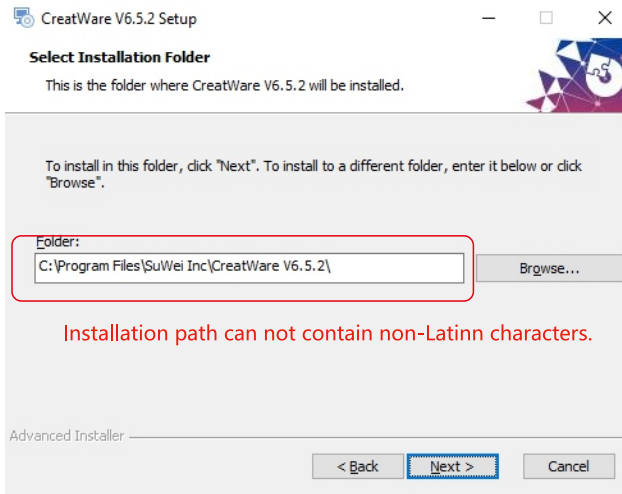

Please associated common 3D file format.

When there is a driver digital signature, please choose to agree. When finished the driver folder will locate at installation directory.

The software will select the correct language according to your OS, please select the right machine type and number of nozzles and ignore the other option and guide.

## Software Operation

### Quick Print UI

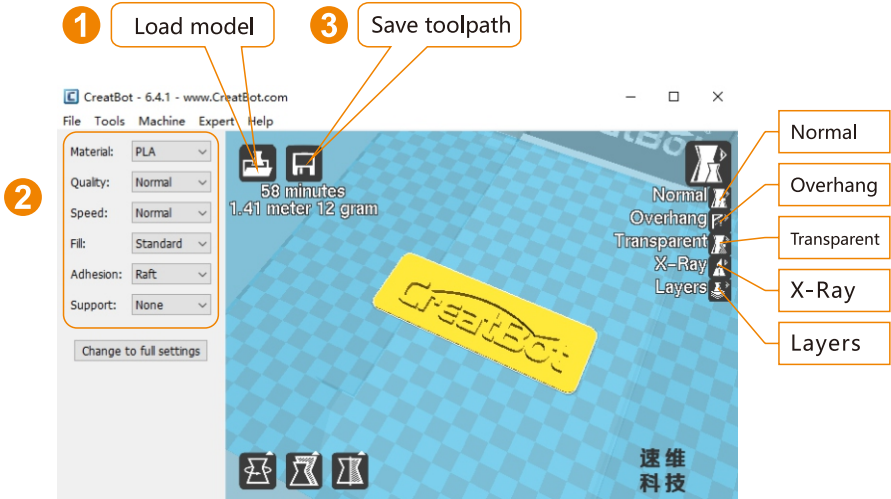

When insert USB-Disk , the toolpath will saved to the USB-Disk.

The file name can not contain non-Latinn characters.

## Print Your First Model

Insert USB-Disk to the card reader, open the Creabot, load 3D model file[1], choose correct filament and option [2], finally click save button[3], you can now finish slice model.

Insert USB-Disk to the printer, browse and select the Gcode file you just saved, the printer will automatically start to heating, when the temperature reaches, the printing will start.



# Software Operation

## Full Setting UI

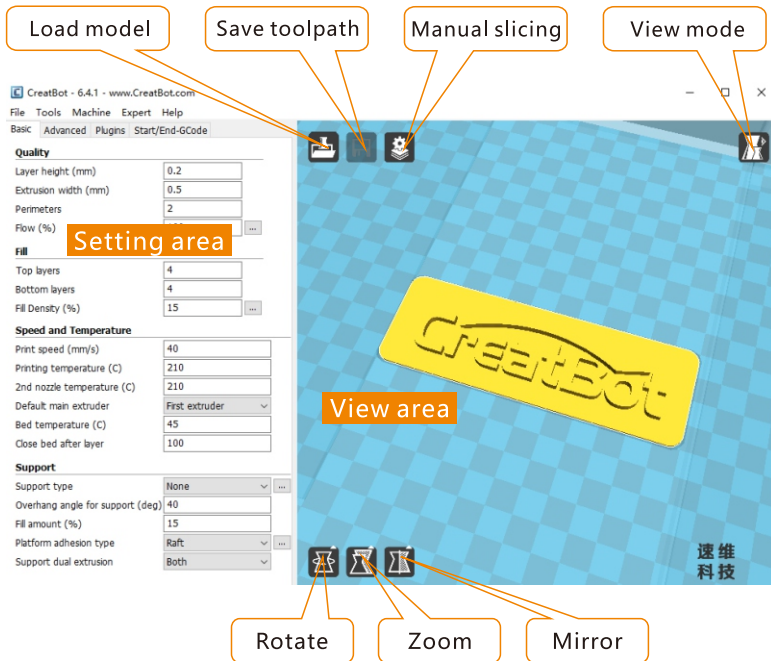

As you can see from the complete UI, the left side of the software is setting area, the right side is view area. The setting area contain "Basic", "Advanced", "Plugins", "Start/End GCode" four tabs. The Basic tab is the most common settings, usually the most frequently used parameters are here. Each parameter has a mouse-over tips, you can set parameters according to the prompt. If you want to restore the default settings, please click on the menu "Tools" -> "Restore Default".



*Tip: Double-click view area can quickly load 3D model file.  
The view mode and edit icon will appear when you select the 3D mode.*

# Software Operation

## Mouse Operation

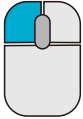

### Left click

Select model, hold and move to change position, double-click to load 3D models.



### Right click

Hold and move to rotate the viewpoint around the 3D model.

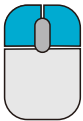

### Left + Right

Hold and move the mouse to zoom.

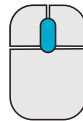

### Scrollwheel

Use the scroll wheel to zoom in or out.

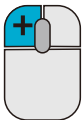

### Left + Shift

Click and drag in rotary model can according to each 1 degree angle.

Shift



### Right + Shift

Hold and move the mouse to pan the 3D view.

Shift

## Keyboard Shortcut

**Ctrl+L** Load model/Picture

**Ctrl+S** Save model as

**Delete** Remove model

**F5** Refresh view area

**Ctrl+E** Export setting

**Ctrl+,** Preferences

# Software Operation

## Model Rotate

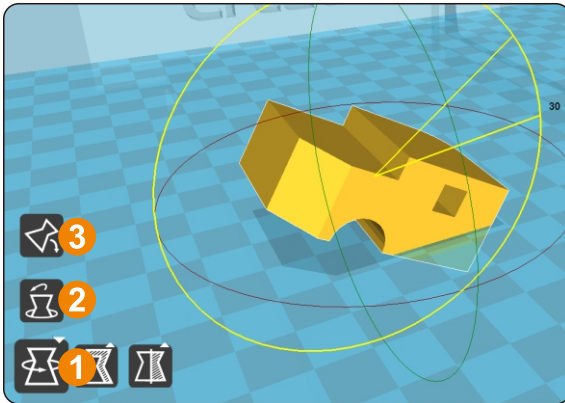

Click on the left corner of the rotate button [1], you can see three ring line around the model, respectively along the X, Y, Z direction. The default rotation angle is 5 degrees, press the Shift key can restrict the rotation angle to 1 degree.

Button [2] is the reset button, can restore rotate status to the default state.

Button [3] is lay flat button, can lay the model flat on the platform automatically.

## Model Scale

Click the left corner of the zoom button [1], you can see a contour line around the model, and shows the current size of the model. You can input the value of the zoom ratio in Scale X / Y / Z , may also directly enter the size you need. Button [4] indicates locking scaling.

Button [2] is zoom reset button, you can restored the model to the default size.

Button [3] for the zoom model size to the maximum print size.

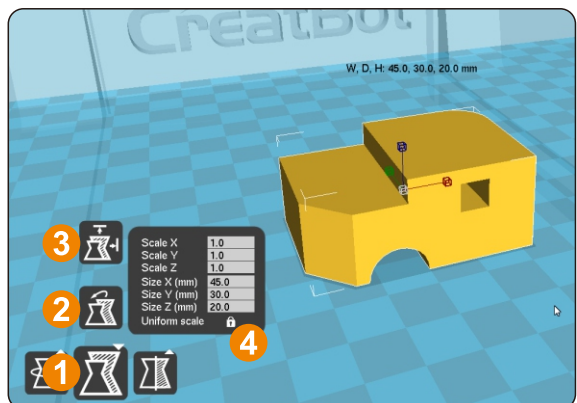

# Software Operation

## Model Mirror

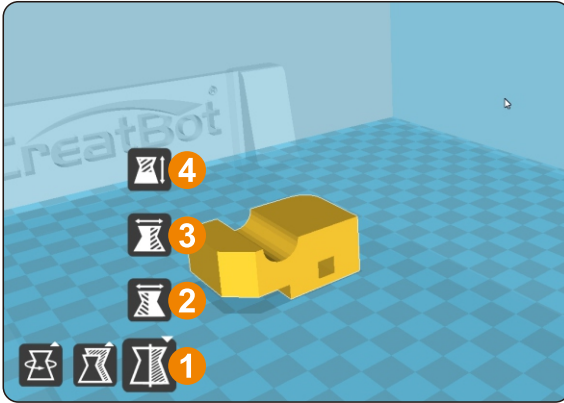

Click the mirror button [1], you can pop up the mirror menu.

Button [2] is a mirror along the X axis.

Button [3] is a mirror along the Y axis.

Button [4] is a mirror along the Z axis.

Note that the mirror transformation is different from the rotation, such as the mirror transformation will lead to a change in the direction of rotation, and the rotation will not change the model.

## View Mode

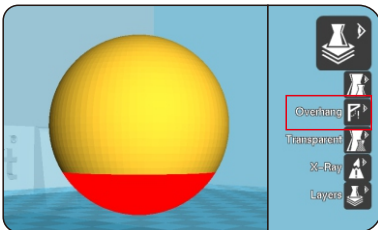

From the overhang view, you can see the suspended part of the model which is shown in red color. By changing the supporting angle can be seen suspended parts size is dynamically changing.

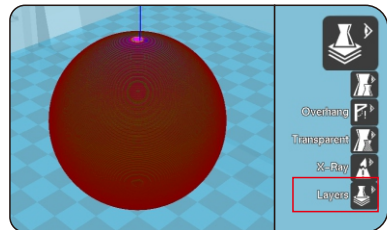

By slice view can easily observe the generated path, you can easily observe the different layers of sliced by slicing altitude indicator, use Ctrl + arrow keys can also be observed layer-by-layer.

# Software Operation

## Right Click on Model

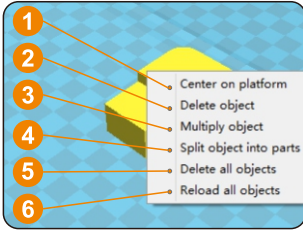

Right-click on the model pop-up shortcut menu, here are more features:

[1] "Centered" make the model back to the center position of the platform. [2] "Delete" to remove the currently selected model. [3] "Multiply" to copy the currently selected model and automatically position, which is useful for printing more than one model at a time. [4] "Split" multi-component model can be split into its separate components, this process more time-consuming, try to split the model in the modeling software, models splited can be printed individually and then assembled together. [5] "Delete All" to delete all the models loaded. [6] "Reload all" Reload all models, same as F5.

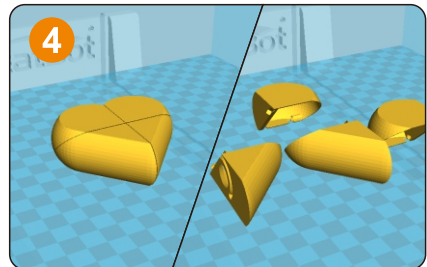
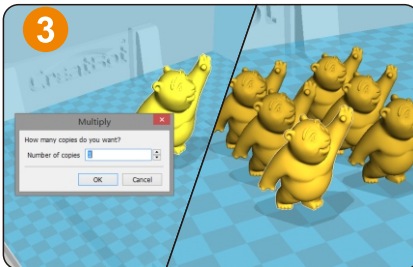

## Toolpath Structure

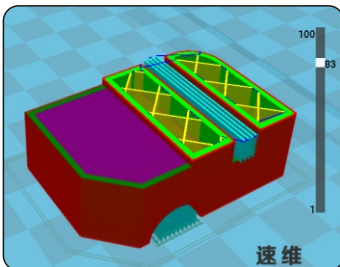

- Red represents "outer shell"
- Yellow represents "infill"
- Green represents "inner shell"
- Blue represents "support"
- Purple represents "bottom and top shell"

Drag layer indicator can browse different level paths, Ctrl + arrow keys to browse layer by layer. 3D printing is the superposition of these different layers and built layer by layer.

# Software Operation

## Basic Setting

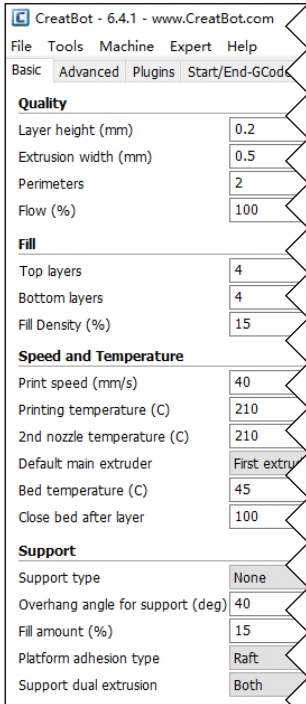

**Layer height:** This is the most important setting to determine the quality of your print, maximum value not exceed 80% of the nozzle diameter.

**Shell thickness:** Refers to the total thickness of the inner and outer walls, the outer wall is only one, the inner wall can be more, set this value to an integer multiple of the diameter of the nozzle.

**Flow:** Refer to the amount of printing material, 100% standard dosage, the more material the model prints more plump.

**top/bottom thickness:** Is the thickness of the upper and lower models, usually a multiple of layer height.

**Fill density:** Control how density filled the insides of your print will be, a value around 20% is usually enough, 0% for hollow.

**Print speed:** Speed at which printing happens. Print speed is affected by many factors, it is recommended to use low speed for complex model, high speed will cause the feed shortage, need improve nozzle temperature to compensate.

**Nozzle temperature:** Is the melting temperature of filament, general use 200°C for PLA and 240°C for ABS.

**Bed Temperature:** General use 45°C for PLA and 70°C for ABS.

**Default main head:** The default is the first nozzle, can also be set to other nozzles, this can reduce the times of changing filament.

**Support type:** The touching build plate support type is shown in figure [A], everywhere support is shown in figure [B].

**Support angle:** The larger the angle, the more support generate.

**Fill amount:** The larger the fill, the more support generate.

**Platform adhesion type:** The model which is not easy adhesion

on the platform please use Brim, which easy to warped or ABS filament please use Raft.

## Support Type

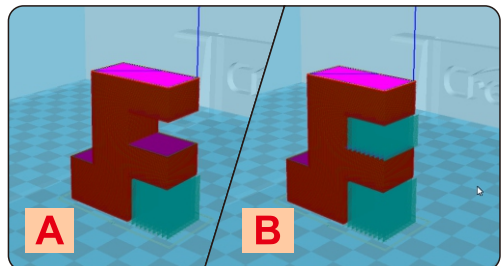

# Software Operation

## Advanced Setting

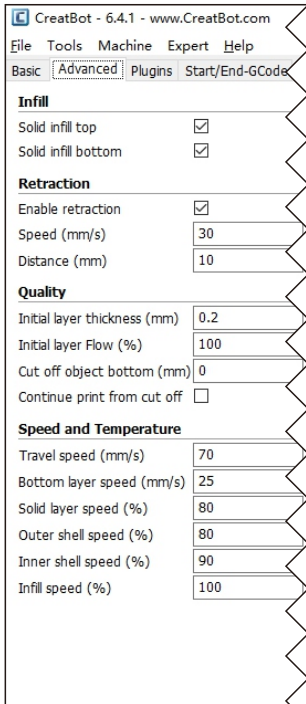

**Solid fill top:** Refers to whether to print the top surface of the model, uncheck will print it with infill method.

**Solid fill bottom:** Same as above, and so on.

**Spiralis print:** Refers to the method of spiral printing the outer wall of the model (single layer), and this feature is very suitable for print glass vase model.

**Enable retraction:** When the nozzle is moving over a non-printed area, withdraw a certain length length filament to prevent overflow.

**Retract speed:** The speed of retraction, too fast can lead motor out of step, too slow increase printing time.

**Retract distance:** The length of the filament when enable retraction.

**First layer thickness:** Height of the first layer of printing, generally greater than 0.15mm. □

**First layer flow:** When the set of the first layer is too high, it can be appropriate to increase the extrusion.

**Cut off object bottom:** This can be used for objects that do not have a flat bottom.

**Continue print:** Being "power outages continued" be substituted.

**Travel speed:** The speed when moving over a non-printed area.

**First layer speed:** Slightly slow speed can enhance adhesion

model on the platform.

**Solid layer speed:** The speed is a percentage here, which reference to the global print speed, a combination of different speeds, you can both get a good print quality and a faster print time.

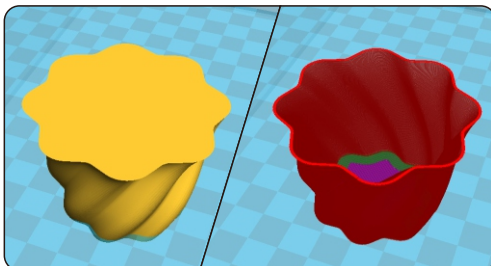

## Spiralise Printing

# Software Operation

## Export Setting

**Nozzle size:** Set the nozzle size.

**Diameter:** Accurate measurement of your filament gives better quality prints.

**Minimum travel:** The minimum distance which can trigger filament retract.

**Minimum extrusion:** The minimal amount of extrusion that needs to be done before retracting.

**Enable combing:** Combing is the act of avoiding holes in the print for the head to travel over.

**Wipe tower:** Is a small tower next to your print where the nozzle wipes itself clean when switching nozzles.

**Dual extrusion switch amount:** Amount of retraction when switching nozzle with dual-extrusion, a value of 15mm seems to generate good results.

**Cooling fan:** The extra cooling fan is essential while printing small model, but when print ABS material, the max fan speed should not more than 50%.

**Skirt:** The skirt is a line drawn around the model at the first layer. This helps to prime your extruder, and to see if the model fits on your platform.

**Brim:** The amount of lines used for a brim, more lines means a larger brim which sticks better.

✕

**Expert config**

<b>Nozzle</b>		<b>Cool</b>	
Nozzle size (mm)	<input type="text" value="0.4"/>	Enable cooling fan	<input checked="" type="checkbox"/>
<b>Filament</b>		Minimal layer time (sec)	<input type="text" value="5"/>
Diameter (mm)	<input type="text" value="3.0"/>	Fan full on at height (mm)	<input type="text" value="0.0"/>
Diameter2 (mm)	<input type="text" value="3.0"/>	Fan speed min (%)	<input type="text" value="100"/>
<b>Retraction</b>		Fan speed max (%)	<input type="text" value="100"/>
Minimum travel (mm)	<input type="text" value="2"/>	Minimum speed (mm/s)	<input type="text" value="10"/>
Minimal extrusion before retracting (mm)	<input type="text" value="0.02"/>	Cool head lift	<input type="checkbox"/>
Z hop when retracting (mm)	<input type="text" value="0"/>	<b>Support</b>	
Enable combing	<input type="text" value="All"/>	Structure type	<input type="text" value="Lines"/>
<b>Dual extrusion</b>		Distance X/Y (mm)	<input type="text" value="1"/>
Wipe&prime tower	<input type="checkbox"/>	Distance Z (mm)	<input type="text" value="0.1"/>
Tower volume per layer (mm3)	<input type="text" value="15"/>	<b>Brim</b>	
Ooze shield	<input type="checkbox"/>	Brim line amount	<input type="text" value="5"/>
Dual extrusion overlap (mm)	<input type="text" value="0.1"/>	<b>Raft</b>	
Dual extrusion switch amount (mm)	<input type="text" value="15"/>	Extra margin (mm)	<input type="text" value="5"/>
<b>Infill</b>		Line spacing (mm)	<input type="text" value="3.0"/>
Infill overlap (%)	<input type="text" value="10"/>	Base thickness (mm)	<input type="text" value="0.3"/>
Infill prints after perimeters	<input checked="" type="checkbox"/>	Thickness (mm)	<input type="text" value="0.25"/>
<b>Black Magic</b>		Airgap (mm)	<input type="text" value="0.2"/>
Spiralize the outer contour	<input type="checkbox"/>	Layers	<input type="text" value="3"/>
Only follow mesh surface	<input type="checkbox"/>	<b>Fix horrible</b>	
<b>Skirt</b>		Combine everything (Type-A)	<input checked="" type="checkbox"/>
Line count	<input type="text" value="1"/>	Combine everything (Type-B)	<input type="checkbox"/>
Start distance (mm)	<input type="text" value="3"/>	Keep open faces	<input type="checkbox"/>
Minimal length (mm)	<input type="text" value="260"/>	Extensive stitching	<input type="checkbox"/>
<input type="button" value="Ok"/>			



*Notice: Most of the setting have been optimized, If you want restore default configuration, use the menu "Tools" -> "Reset profile to default".*



# Software Operation

## Skirt · Brim · Raft

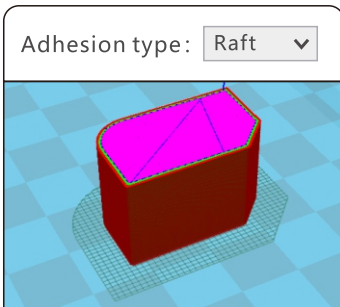
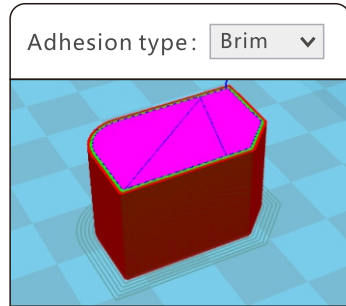
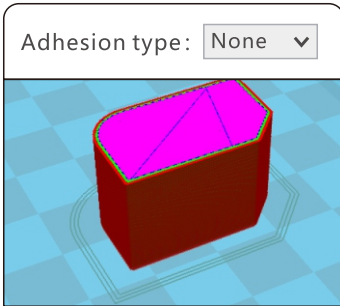

Plugin enable you to easily include your own features, without having to modify the source code or Gcode. In the screen shot above, these can be enabled by clicking on the arrow down button, then you can configure the plugin.



*Notice: Please remove the plugin before you close the software.*

## Plugins

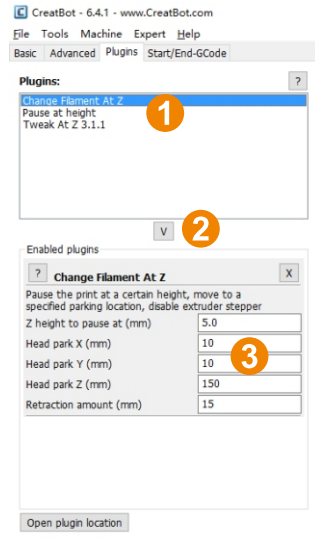

# Software Operation

## Start / End GCode

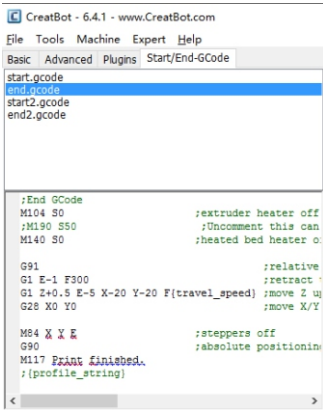

The start and end gcode are the startup and end procedure of the print, editing this requires knowledge of GCode.

If you want to set the automatic heating station after printing, you can remove the ";" in the code ";M190 S50".

start.gcode is the start code of single extruder, start2.gcode is the start code of double extruder, and so on.

## Dual Head Printing

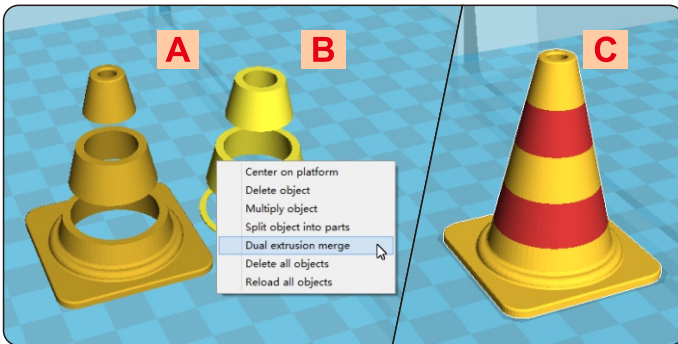

**Step 1:** Load 2 models you want as shown in figure [A] and [B].

**Step 2:** First click [A], then right click on [B], you will get the option: dual extrusion merge, this will merge both models into

one model [C].

**Step 3:** Set parameters like ordinary single color model and save the GCode.



*Tip: The model select first will print by main extruder, the right clicked one by second extruder.*

# Software Operation

## Align Dual Head Horizontal

Machine settings ×

**CreatBot\_DX\_2**

<b>Printer settings</b>		<b>Printer head size</b>	
E-Steps per 1mm filament	<input type="text" value="0"/>	Head size towards X min (mm)	<input type="text" value="75.0"/>
Maximum width (mm)	<input type="text" value="305"/>	Head size towards Y min (mm)	<input type="text" value="18.0"/>
Maximum depth (mm)	<input type="text" value="255"/>	Head size towards X max (mm)	<input type="text" value="18.0"/>
Maximum height (mm)	<input type="text" value="305"/>	Head size towards Y max (mm)	<input type="text" value="35.0"/>
Extruder count	<input type="text" value="2"/>	Printer gantry height (mm)	<input type="text" value="60.0"/>
Heated bed	<input checked="" type="checkbox"/>	<b>Communication settings</b>	
Machine center 0,0	<input type="checkbox"/>	Serial port	<input type="text" value="AUTO"/>
Build area shape	<input type="text" value="Square"/>	Baudrate	<input type="text" value="AUTO"/>
<b>Extruder 2</b>			
Offset X	<input type="text" value="20.0"/>		
Offset Y	<input type="text" value="0.0"/>		

There are alignment problem while printing dual color model, this is because the small difference in multi-nozzle assembly, CreatWare built fine-tuning features.

Click menu "Machine">"Machine settings", default X offset is: 20.0, default Y offset is: 0.0, adjustment method as shown below:

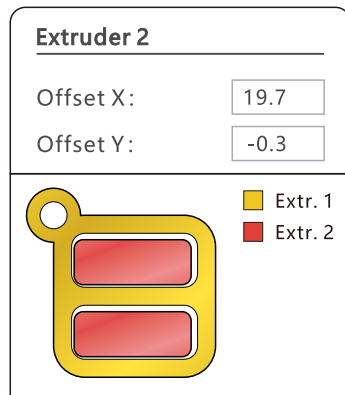
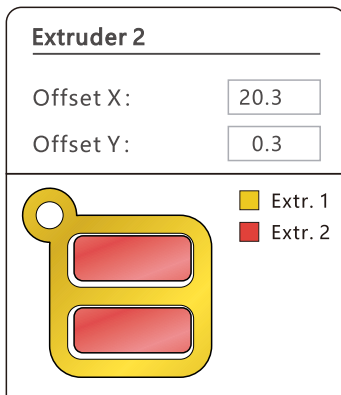

# Extruder Regulation

## Align Dual Head Vertical

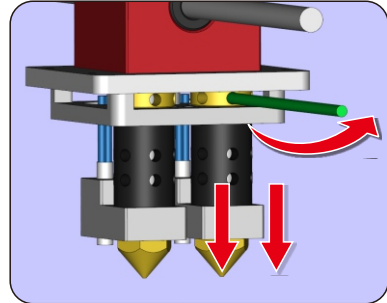
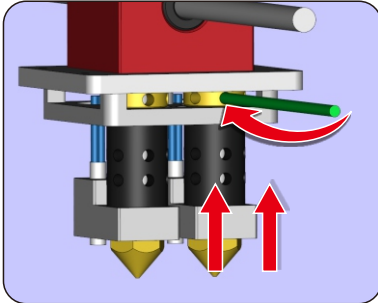

**Step 1:** Raised the right nozzle. Rotate left to raise the head, rotate right to lower head, the full rotation adjustment range is 1mm per round.

**Step 2:** Leveling with the left nozzle. □

**Step 3:** Lower right nozzle step by step align with the left nozzle.  
(The new Printer Head also use this method to adjust machine)



*Tip: You can rising right nozzle as long time not use.*

## Add Multi Type Printer

You can add more than one type of CreafBot to the software, and easily switch between them without re-config all the different machine

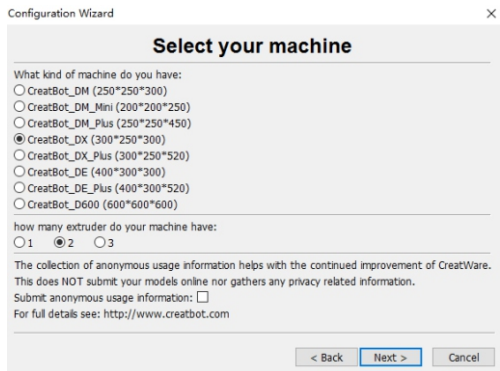
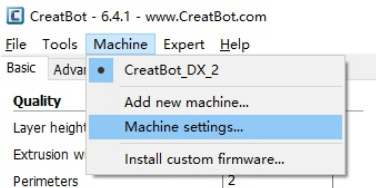

# Using skills

## Print Setting Of Different Filament

	Nozzle temperature	Hot bed	Platform adhesion type	Fully enclose or not
PLA	190~210°C	None/45°C	None/Raft	Can open
ABS	230~250°C	90°C	Brim/Raft	Enclosed
Nylon	240~270°C	100	Brim/Raft	Enclosed
HIPS	230~260°C	100°C	None/Brim	Enclosed
PETG	230~260°C	100°C	None/Brim	Enclosed
Flexible	210~230°C	None/45°C	None	Can open
Wood	190~220°C	None/45°C	None	Can open
PC	230~260°C	100°C	Brim	Enclosed

\* The data is only for reference, different environmental data will be different.

# Using skills

## Change Fuse



Open fuse tray



Change new fuse

*Note: Please use the 10A fuse.*

## Routine Maintenance

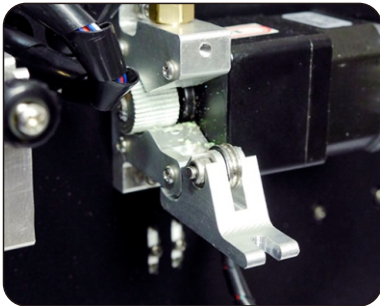

1. Frequent cleaning stains on the rail.
2. Lubricate the four guide rail.
3. Frequent cleaning feeder gear.



*Notice: Don't add too much lubricating oil.*

# Using skills

## Installation section

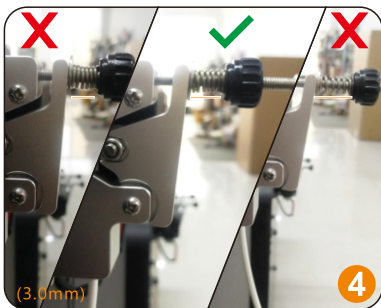
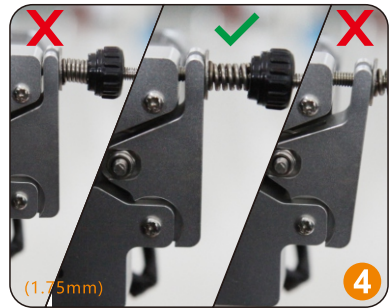
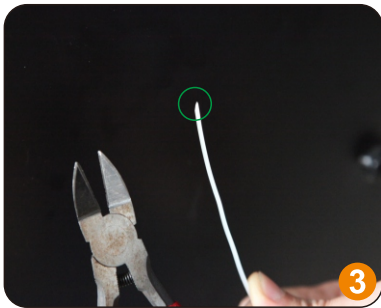
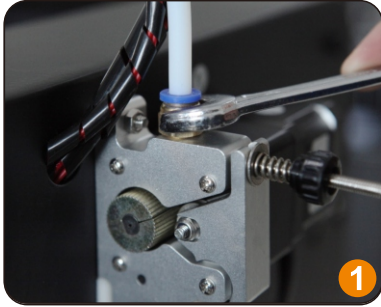

1. Tighten quick connector. Otherwise, quick connector may separate from extruders.

2. Installing filament sleeve can prevent filament winding.

3. Heat nozzle before loading filament. Sharpen Filament Head and Make Filament Straight before loading (Especially for 1.75mm filament)

4. Insert the end of the material into feeder and gently push it into the hot end until you see the silk from print head

If you have difficulty in pushing, please gently shake the fore end of feeder to make sure the material can reach into the hot end. Then tighten pressure nut. Screw 5~8 lbs from the beginning of spring in force. Neither too loose nor too tight. If filament is 1.75mm in diameter, then 8-10 lbs is suitable.

# Using skills

## Software

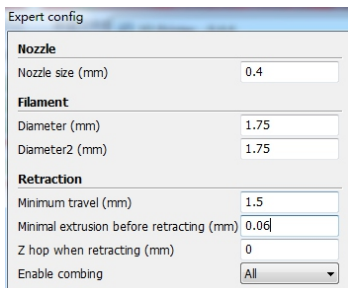

- 1.If your machines are equipped with 1.75mm parts, you have to setting below:  
Expert-open expert setting... Filament diameter (1.75mm).  
Expert-open expert setting... Minimal extrusion before retracting (0.06mm)  
Advance-Retracton-Distance to 1.5mm
- 2.If your machines are equipped with different diameter nozzle (default

0.4mm). You have to setting:

Expert-open expert setting... Nozzle size (same to yours)

Basic-Quality-Extrusion width (same to yours)

- 3.Small objects need lower hotend temperature around 190~200°C.

Large objects better to use Support-Raft. Easy to stick when start printing.Easy to remove when finish printing.

- 4.Machine-machine setting. You can customize your machine size.

## Adjust Z Limit

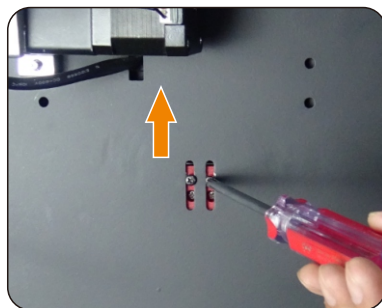
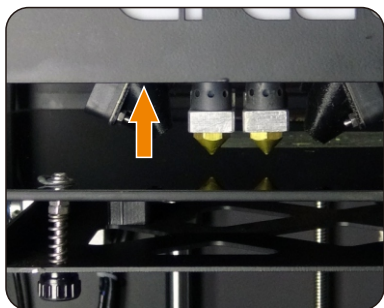

If the nozzle can't touch the platform even loosen all the leveling nut, you can move Z stop limit a little up, as you can see from figure.



# Frequently Asked Questions

## Hardware Troubleshoot

### **1. Display "MINTEMP" ?**

The environment is too low, or temperature control tube is damaged, please keep the room temperature above 0°C.

### **2. Display "MAXTEMP" ?**

Temperature of nozzle or bed too high, or temperature control tube is damaged, please keep their temperature in a suitable range.

### **3. USB connection problems ?**

Please specify the correct port and baud rate (250000), or change a shorter USB cable.

### **4. Nozzle heats up too slowly ?**

Temperature in door is too low, or use a fan duct, or turn up output voltage (24.5v).

### **5. Print head stuck ?**

Clean the guide rail and add lubricating oil.

### **6. Print head can not move ?**

Stepper motor chipset burned, or belt damaged, or belt wheel screw loose.

### **7. Print head hit the framework ?**

Corresponding axis stop limit or circuit fault.

### **8. Unable to power on ?**

Power switch is damaged or fuse is burned, and please check whether the power adapter is working properly.

## Printing Troubleshoot

### **1. How to set the temperature of the nozzle ?**

Different filament temperature is different, general as follows:

PLA temperature 190°C ~210°C

ABS temperature 230°C ~250°C

You must leave enough time for filament heating, so the faster printing speed need the higher temperature, 60mm/s temperature need raise about 10°C. In the same way, larger thickness need higher temperature.

### **2. How to set the temperature of the hot bed ?**

The main purpose of the hot bed is to prevent model wrapped, PLA need about 45°C and 70°C for ABS is enough, but due to the environment and filament, we often need to increase the temperature, the highest temperature

# Frequently Asked Questions

## Printing Troubleshoot

not over 120°C, and you can close the bed above 100mm.

### **3. The model not stick on the platform ?**

Please paste masking paper or Kapton on the platform, or the nozzle is too far away from the platform, or the bottom of the model is not flat.

### **4. No or less silk coming on the first layer ?**

The distance between nozzle and platform is too small, or the filament has not been sent to the nozzle.

### **5. Why nozzle is not spit silk ?**

The filament is not pressed or too tight, or print temperature is too low, or the filament feeder not working.

### **6. How to prevent model become warped ?**

Increase hot bed temperature or use Kapton, or change platform adhesion type to Raft, or cover the baffle, or reduce indoor ventilation.

### **7. How far from nozzle to platform appropriate ?**

Distance should be 0 in theory, but there is no absolute flat platform, so the distance should  $\pm 0.1$ mm. Finally, with the actual printing effect as the standard, too close will lead to a silk blocked, too far will cause the model not stick on the platform.

### **8. How to determine whether the temperature is too high ?**

PLA temperature is too high will appear liquefaction, ABS will be the carbide, that will block the nozzle.

### **9. What reasons will causing nozzle blocked ?**

Filament are impurities or print environment dust too much, bad of thermal conductivity between the nozzle and the heating block.

### **10. Model surface is loose with crack ?**

The layer is too high or the printing speed too fast, nozzle temperature too low or filament press nut too loose, or filament is wrapped.

### **11. How to print a small model ?**

Multiple the model, and print them at a time.

### **12. Dual color model not aligned ?**

Adjust offset of second nozzle in machine settings.



### **13. Dual color model color interference ?**

Align two nozzle in vertical direction

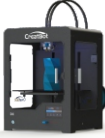

### **14. There is too much silk drag on the model ?**

Please enable filament retraction, and specified proper retract speed, and distance, the retract distance should not less than 4mm, and the speed not less than 10mm/s.

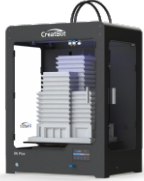

## Specifications

				
Model	DX	DX Plus	DE	DE Plus
Single Extrusion	300*250*300	300*250*520	400*300*300	400*300*520
Dual Extrusion	280*250*300	280*250*520	380*300*300	380*300*520
Triple Extrusion	260*250*300	260*250*520	360*300*300	360*300*520
Nozzles	Dual/Tris			
Diameter	0.4mm(0.3/0.6/0.8/1.0mm can be customized)			
Temperature	350 °C			
Nozzles Type	print head/new print head			
Hot bed	100 °C (can be closed after certain layers)			
Min. Layer	0.04mm			
Accuracy	X、Y、Z axis 0.05mm			
Print Speed	40-120mm/s (inner/outer, top/bottom, fill, first layer speed can be setting)			
Travel Speed	200mm/s			
Materials	ABS,PLA,TPU,PETG,HIPS,PVA, PA,PC,Carbon Fibre,etc			
Fila. Diameter	3.0mm (1.75mm optional)			
Auto Turnoff	Yes (pwr manager + relay)			
Continue Play	Yes (Power outage, lower plate and save data)			
Fila. Check	Yes (pause printing when filament finish, and lower platform)			
Adju. Head	Yes (height-adjustable-nozzles)			
OS	Windows, Mac OS			
Languages	Chinese, English multi-language			
Software	CreatWare Multi-language			
File Format	STL, OBJ, GCode, Amf			
Chipset	Atmega 2560-16AU (AVR 8 Bit 16MHz , 256KB Flash)			
Display	4.3 inch touch screen			
Pwr Supply	110/220V 360W		110/220V 700W	
Dimension	420*380*570	420*380*790	590*430*570	590*430*790
Weight	35 Kg	40Kg	45Kg	55Kg

## Specifications

			
Model	F160	F430	D600
Build volume	160*160*200	400*300*300	600*600*600
Dual Extrusion		320*300*300	540*600*600
Nozzles	Single	Dual	
Diameter	0.4mm(0.3/0.6/0.8/1.0mm can be customized)		
Temperature	260°C ( support max 420°C )		350°C
Nozzles Type	Direct drive		
Hot bed	140°C	Bed 120°C/Air 70°C	100°C
Min. Layer	0.01mm	0.02mm	0.05mm
Accuracy	X、Y、Z axis 0.05mm		
Print Speed	120mm/s (inner/outer, top/bottom, fill, first layer speed can be set separately)		
Travel Speed	200mm/s		
Materials	ABS,PLA,TPU,PETG,HIPS,PVA, PA,PC,Carbon Fibre,PEEK,etc		
Fila. Diameter	1.75mm		3.0mm
Motion Structures	Optic axis	guide rail	Rectilinear orbit
Auto Turnoff	Yes (pwr manager + relay)		
Continue Play	Yes (Power outage, lower plate and save data)		
Fila. Check	Yes (pause printing when filament finish, and lower platform)		
Adju. Head	Yes (height-adjustable-nozzles)		
OS	Windows, Mac OS		
Languages	Chinese, English multi-language		
Software	CreatWare Muti-language		
File Format	STL, OBJ, GCode, Amf		
Printing Field	Full closed covering		
Display	4.3 inch touch screen		
Pwr Supply	110/220V 180W	110/220V 1300W	110/220V 1000W
Dimension	280*280*470mm	660*470*560mm	910*840*1100mm
Weight	22Kg	60Kg	170Kg

## Specifications

		
Model	PEEK-300	F1000
Build volume	300*300*400mm	1000*1000*1000mm
Dual Extrusion	240*300*400mm	940*1000*1000mm
Nozzles	Double	
Diameter	0.4mm(0.3/0.6/0.8/1.0mm optional)	1.0 mm (0.4~1.5 mm)
Temperature	Max 500°C	Max 420°C
Hot bed	Max 200 °C	Max 100°C
Min. Layer	0.05mm	0.05mm
Accuracy	X.Y0.011mm;Z 0.025	X.Y0.011mm;Z 0.025
Print Speed	10-150 mm/s	10-120 mm/s
Materials	ABS,PLA,Carbon Fiber,PETG,Nylon,PC,etc.	
Fila. Diameter	1.75 mm	
Auto Turnoff	Yes (pwr manager + relay)	
Continue Play	Yes (Power outage, lower plate and save data)	
Fila. Check	Yes (pause printing when filament finish, and lower platform)	
Adju. Head	Yes (height-adjustable-nozzles)	
OS	Windows, Linux, Mac OS, OSX	
Languages	Chinese, English	
Software	CreatWare Muti-language	
File Format	STL, OBJ, GCode, Amf	
Chipset	Atmega 2560-16AU (AVR 8 Bit 16MHz , 256KB Flash)	
Display	4.3 inches color touch screen	9.7 inches color touch screen
Pwr Supply	200V~240V, 20A	220~240 V, 50~60 Hz;4000W
Dimension	650*600*750 mm	1910*1510*2205mm
Weight	100 kg	640 kg



Quality · Experience · Service

### **Henan Creatbot Technology Limited**

---

Telephone: +86 4000-558-930

Website: [www.CreatBot.com](http://www.CreatBot.com)

Email: [sales@creatbot.com](mailto:sales@creatbot.com)

Address: 6#, Chaoya Industry Park,  
Hanghai Road, No.13 Ave.,  
Eco-Tech Development Zone,  
Zhengzhou City, Henan Province, China